

**Fitnex**



**Treadmill TF55/T60/T70**

---

**User Manual TMNA:04**

Grounding Instructions.....	1
Compliance.....	2
Safety Instructions.....	3-4
Installation.....	5
Levelling Legs.....	6
Overview.....	7
Latching & Un-Latching Locks.....	8
TF55/T60.....	9-17
T70.....	18-31
Stretching and Flexibility.....	32-33
Maintenance.....	34
Warranty.....	35-36

This product must be grounded. If it should malfunction or breakdown, grounding provides a path of least resistance for electric current to reduce the risk of electric shock. This product is equipped with a cord having an equipment-grounding conductor and grounding plug. The plug must be plugged into an appropriate outlet that is properly installed and grounded in accordance with all local codes and ordinances.

**DANGER-**Improper connection of the equipment-grounding conductor can result in a risk of electric shock. Check with qualified electrician or serviceman if you are in doubt as to whether the product is properly grounded. Do not modify the plug provided with the product - if it will not fit the outlet, have a proper outlet installed by a qualified electrician.

This product is for use on a nominal 120-volt circuit (230 optional) and has a grounding plug that looks like the plug illustrated in the figure. Make sure that the product is connected to an outlet having the same configuration as the plug. No adapter should be used with this product.

- The appliance must be positioned so that the plug is accessible.
- If the power cord is damaged, it must be replaced by the manufacture or its service agent or a similarly qualified person. In order to avoid an electrical hazard.

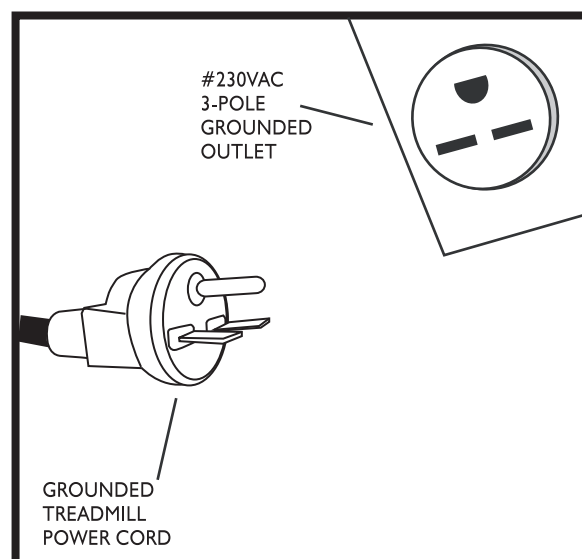
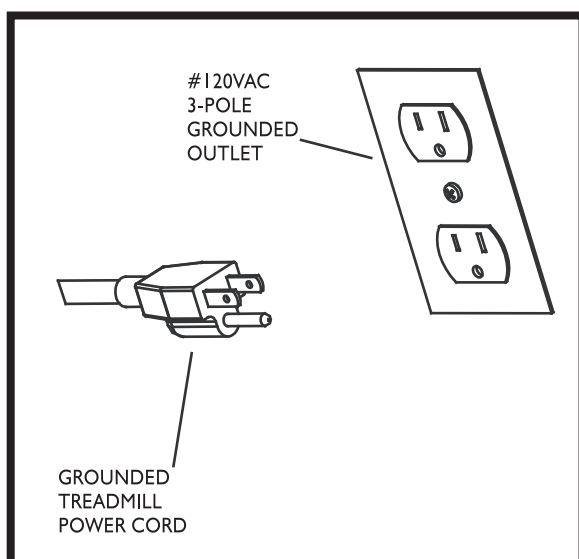

P.S. Different countries may use different voltage and shape of power cord outlet.



## **FCC WARNING-POSSIBLE RADIO**

### ***/TELEVISION INTERFERENCE***

**NOTE:** This equipment has been tested and found to comply with Part 15 of the FCC rules. These limits are designed to provide reasonable protection against harmful interference in a residential installation. Any changes or modifications not expressly approved by the party responsible for the compliance could void the user's authority to operate the equipment. This equipment generates, uses and can radiate radio frequency energy and, if not installed and used in accordance with the instructions, may cause harmful interference to radio communications. However, there is no guarantee that the interference will not occur in a particular installation. If this equipment does cause harmful radio interference to radio or television reception, which can be determined by turning the equipment off and on, you are encouraged to try to correct the interference by one or more of the following measures:

- Reorient or relocate the receiving antenna
- Increase space between the equipment
- Plug the equipment into two electrical outlet located on separate circuits
- Consult an exercise equipment dealer or an experienced radio/TV technician for help

Class R (Residential): Private or non-commercial use

When using an electrical product, basic precautions should always be followed, including the following:

Read all instructions before using this exercise product. The use of this product in any way not described in this manual is not recommended and may cause serious or fatal injury or void your warranty.

## **WARNING!**

To reduce the risk of burns, fire, electrical shock or injury to persons:

- Use this exercise product for its intended use as described in this Manual . Do not use attachments not recommended by the manufacturer.
- Never drop or insert any object into any opening.
- Do not remove the Treadmill motor covers or roller covers. Service should be performed only by an authorized FITNEX retailer.
- Never operate this Treadmill if it has a damaged cord or plug, if it is not working properly, if it has been damaged, or immersed in water. Return the Treadmill to a retailer for examination and repair.
- Keep the cord away from heated surfaces.
- Do not use outdoors.  
To disconnect, turn the switch to the OFF position, then remove plug form outlet.
- Never place the power cord under carpeting or place any object on top of the power cord, which may pinch and damage it.
- Unplug your Treadmill before moving it.
- When the FITNEX Treadmill is in use, young children and pets sould be kept at least 10 feet away.



## **CAUTION**

FITNEX firmly recommends that you have a complete medical exam by a qualified physician before beginning any exercise program, particularly if you have a family history of high blood pressure or heart disease, are over the age of 45, or if you smoke, have high cholesterol, are obese or have not exercised regularly in the past year. If, at any time while exercising, you feel faint, dizzy, pain or a shortness of breath, stop exercising immediately.

## **PROPER USE**

- DO NOT use this product unless proper attire is worn. Rubber-soled training, running, or tennis shoes must be worn to provide proper traction and protection while using this product.
- DO NOT use cleats, spikes or any other non-athletic style shoes.
- DO NOT use this product while barefoot or wearing only socks.

## **ELECTRICAL REQUIREMENT**

Your FITNEX treadmill is intended for use in the country to which it was shipped. Electrical supplies outside of this country may differ and may not be compatible with the product. Please consult Customer Support or your dealer before using the treadmill in a different country.

## **LOCATION**

When choosing a location for the treadmill, pick a location that is unobstructed. The treadmill must have the following clearance.

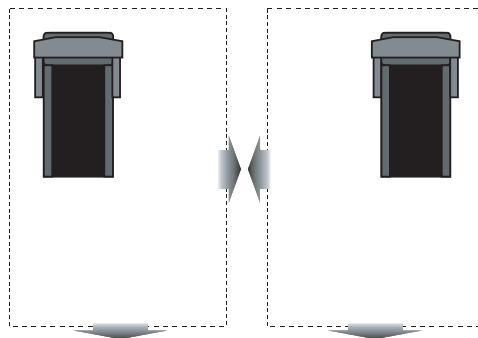

- Non-entry side of treadmill - Minimum of 8 inches (20cm)
- Entry side of treadmill - Minimum of 36" (90cm)
- Front of the treadmill - Minimum of 12 inches (30cm)
- Behind treadmill - Minimum of 6 feet (180cm)

These spacing requirements are mandatory for the safe use of the treadmill. If an accident should occur, you must have sufficient space to move away from the treadmill.

## **GROUNDING INSTRUCTIONS**

The treadmill must be properly grounded prior to use. Proper grounding reduces the risk of shock or damage to the treadmill. The powercord's plug is equipped with a grounding conductor that must be used with an electrical outlet installed in accordance to all local codes and ordinances. **DO NOT** use a temporary adapter that bypasses this function. This will stop the safety equipment from functioning properly and may void your warranty.

DO NOT MODIFY the plug provided with this product. If it will not fit an electrical outlet, have a proper outlet installed by a qualified electrician.

## LEVELLING LEGS

After finding a location that is suitable for the treadmill, the rear legs must be adjusted to provide stable support. Located on the side of each leg is a thumb-wheel that will allow you to lower or raise the leg until it is properly seated on the floor.

DO NOT adjust legs while the treadmill is on. Turn the power switch to the OFF position before adjustment.

**TF55**

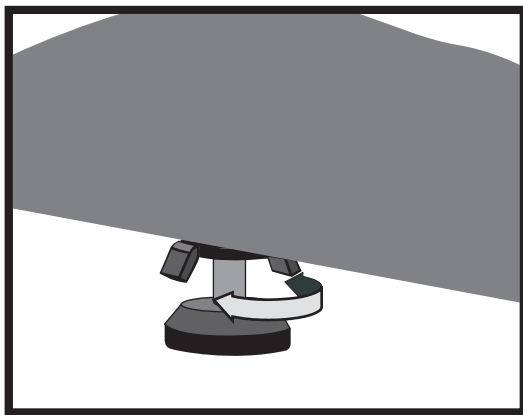

**T60**

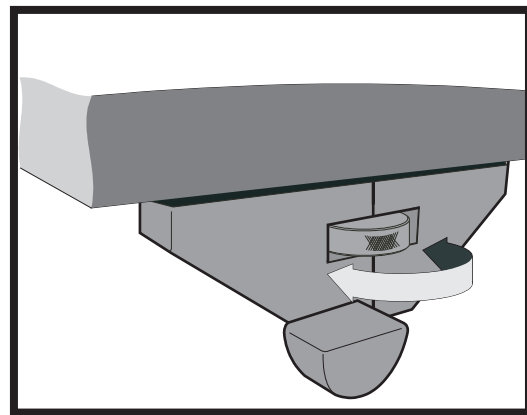

**T70**

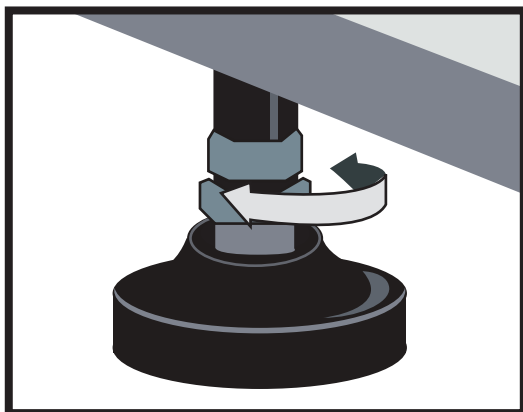



## POWER SWITCH

The power switch is located on the side of the treadmill near the power cord. The power switch has two positions - ON and OFF. The display console will beep when the treadmill is plugged in and the power switch is pressed ON.

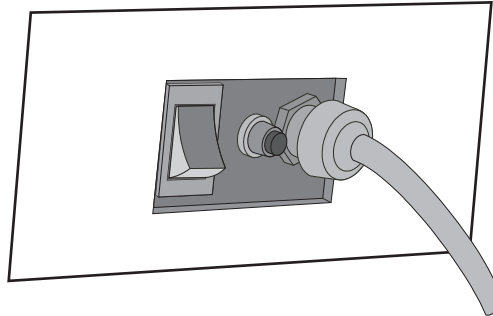

## CIRCUIT BREAKER RESET

The circuit breaker is located next to the power switch. Should an electrical overload occur due to a surge in electricity or other situation, the circuit breaker will disconnect to prevent any damage from occurring to the treadmill.

If the treadmill suddenly stops with no lights visible nor beep heard, reset the circuit breaker. To reset the circuit breaker press the button firmly. The display console should restart and a beep should be heard.





## CAUTION

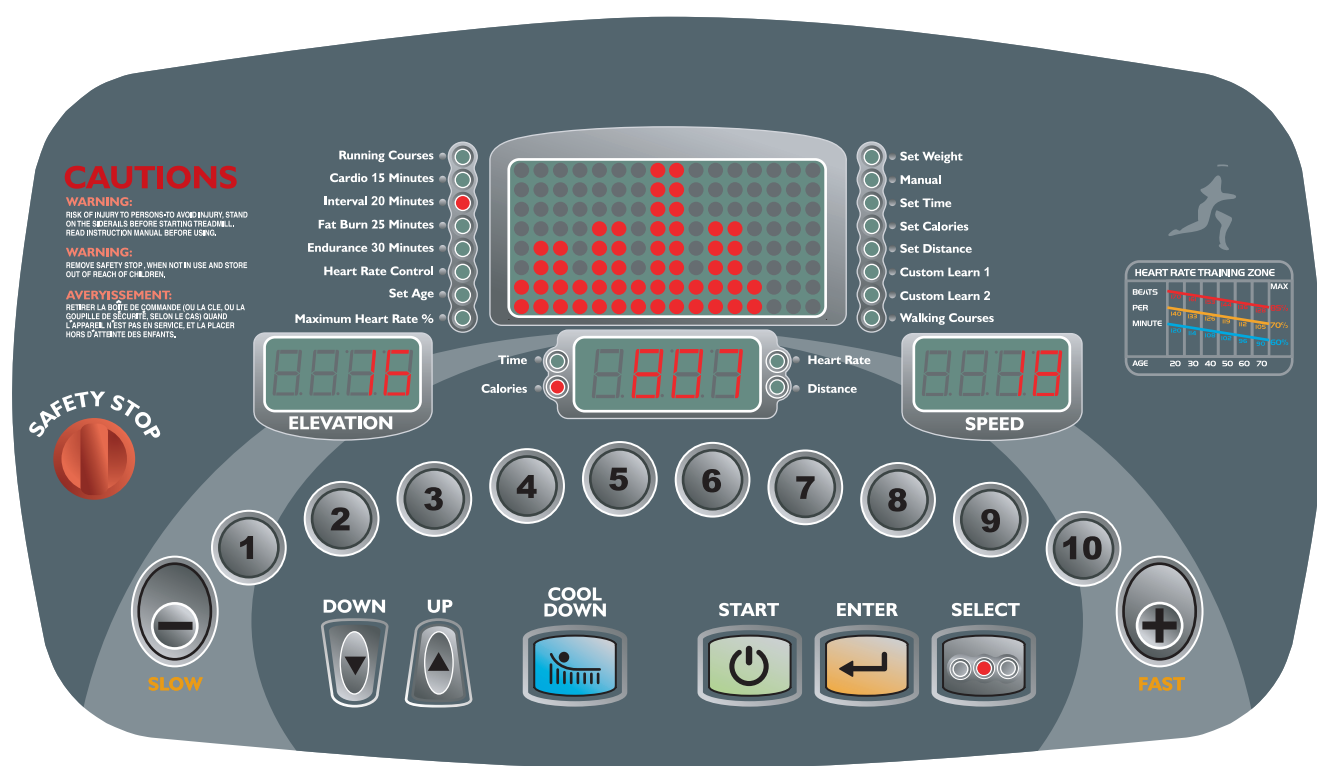

If the power cord is warm to the touch a problem may exist with the electrical outlet in which the treadmill is plugged. It may be necessary to plug the treadmill into a different outlet.

## POWER CORD



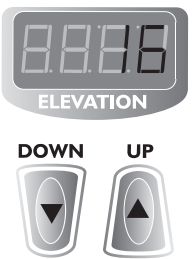

Plug the power cord into a properly grounded electrical outlet, keep power cord clean of treadmill wheels during operation. Replace the power cord if it is damaged or pinched. Damage to the power cord could result in a fire hazard or cause personal injury through electrical shock.















	<p><b>SAFETY STOP:</b> Pulling the safety magnet stops the treadmill immediately.</p>
	<p><b>START:</b> Begins workout.</p>
	<p><b>ENTER:</b> Accept entry of variable setting.</p>
	<p><b>SELECT:</b> Select an exercise program. Use to scan the Time / Calories / Distance / Heart Rate during workout.</p>
	<p><b>SPEED:</b> Increase / Decrease the tread belt speed.</p>
	<p><b>ELEVATION:</b> Increase / Decrease the elevation of treadmill.</p>

	<p><b>COOL DOWN:</b> Press COOL DOWN, elevation returns to 0%.</p> <ul style="list-style-type: none"> <li>■ If the current speed is higher than 5 MPH (8KMH), speed returns to 0 in 3 minutes.</li> <li>■ If the current speed is between 1.6~5 MPH (2.56~8KMH), speed returns to 0 in 2 minutes.</li> <li>■ If the current speed is lower than 1.6 MPH, (2.56KMH) speed returns to 0 in 18 seconds.</li> </ul>
	<p><b>PAUSE/RESET:</b> Press PAUSE for temporary stop which holds the time and distance. Press START to continue. To reset the treadmill hold the PAUSE down for 3 seconds.</p>
	<p><b>One Touch Speed Buttons</b> Select speed from 1 to 10 MPH.</p>











**Manual**

Step 1	Turn on the power and put the safety key on.
Step 2	Set weight. You can use “  ” and “  ” to adjust your weight, then press “  ”.
Step 3	Press “  ” to start your workout.









## Set Time/Set Calories/Set Distance

Step 1	Turn on the power and put the safety key on.
Step 2	Set weight. You can use “  ” and “  ” to adjust your weight, then press “  ”.
Step 3	Press “  ” to choose one of these three programs, then press “  ”.
Step 4	<p>If you choose “Set Time”, you can use “  ” and “  ” to adjust the time you want to exercise.</p> <p>If you choose “Set Calories”, you can use “  ” and “  ” to adjust the calories you want to exercise.</p> <p>If you choose “Set Distance”, you can use “  ” and “  ” to adjust the distance you want to exercise.</p> <p>After adjusting, please press “  ”.</p>
Step 5	Press “  ” to start your workout.

## Custom 1/ Custom2







Step 1	Turn on the power and put the safety key on.
Step 2	Set weight. You can use “  ” and “  ” to adjust your weight, then press “  ”.
Step 3	Press “  ” to choose one of these two programs, then press “  ”.
Step 4	Set each segment’s speed by pressing “  ” and “  ”. Set each segment’s elevation by pressing “  ” and “  ”. After setting up a segment, please press “  ” to set up next segment.
Step 5	After setting 30 segments, please press “  ” to start your workout.

## Walking Course/ Running Course













Step 1	Turn on the power and put the safety key on.
Step 2	Set weight. You can use “  ” and “  ” to adjust your weight, then press “  ”.
Step 3	Press “  ” to choose one of these two programs, then press “  ”.
Step 4	Press “  ” when you see TIM on the matrix window.
Step 5	Use “  ” and “  ” to adjust the time you want to exercise.
Step 6	Press “  ” to start your workout.



**Calories 15 Minutes/Interval 20 Minutes/  
Fat Burn 25 Minutes/Endurance 30 Minutes**

Step 1	Turn on the power and put the safety key on.
Step 2	Set weight. You can use “  ” and “  ” to adjust your weight, then press “  ”.
Step 3	Press “  ” to choose one of these four programs, then press “  ”.
Step 4	Press “  ” to start your workout.

## Heart Rate Control

Step 1	Turn on the power and put the safety key on.
Step 2	Set weight. You can use “  ” and “  ” to adjust your weight, then press “  ”.
Step 3	Press “  ” to choose the programs, then press “  ”.
Step 4	Set age. You can use “  ” and “  ” to adjust your age, then press “  ”.
Step 5	Set Maximum Heart Rate %. You can use “  ” and “  ” to adjust, then press “  ”.
Step 6	Press “  ” to start your workout.

**IMPORTANT NOTE:** You need to wear a chest belt before starting this program.

## Lower Back, Hips, Groin, and Hamstrings

1. Stand with the feet about shoulder-width apart and pointed straight ahead. If you are pretty flexible and need more of a stretch, cross one leg in front of the other for a few stretches, then switch legs.
2. Slowly bend forward from the hips, always keeping your knees slightly bent.
3. Stretch only to the point where you feel a tugging in the back of your legs.

## Side Bends

1. Stand with your feet about shoulder-width apart and toes pointed straight ahead. Keep your knees slightly bent, one hand on your hip; extend your other arm up and over your head. Slowly bend at your waist to one side, toward the hand on your hip.
2. Extend both arms overhead. Hold your right hand with your left hand and bend slowly to the left, using your left arm to pull the right arm gently over the head and down toward the ground.
3. Repeat with other side.

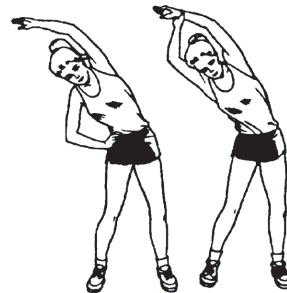

## Quadriceps (front of thigh)

1. Lying on our stomach, pull the heel toward your buttocks with the opposite hand. Keep the thigh of the leg being stretched close to the leg on the floor.
2. The same stretch can be done standing. Do not allow the thigh to come in front of you and so not bend forward at the waist.
3. Do this exercise twice - once on each leg.

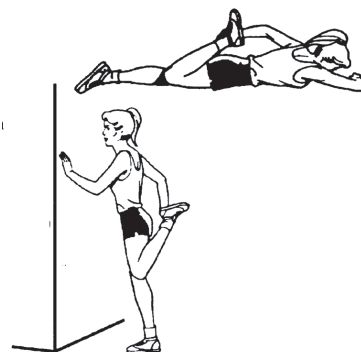

## Groin (inside of thigh)

1. Sit on the floor with the soles of your feet together. Gently push knees down toward the floor with your elbows.
2. Stand with your feet three to four feet apart and turned out slightly.
3. Keep the knee of the leg to be stretched straight, and bend the opposite knee as you move your body toward the bent leg. Keep your toes pointed forward.
4. Repeat using the other leg

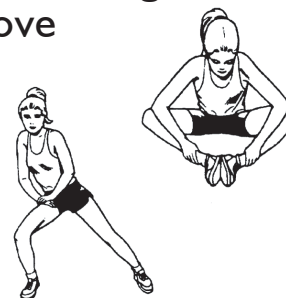

## Hamstrings (back side of upper leg)

1. Sit with one knee bent and the leg to be stretched out straight. Reach for the toes of the straight leg with the right hand and then the left hand.
2. Repeat with the other leg.



## Gluteus (back of hip)

1. Lie on your back. Pull one knee up to your chest while keeping the opposite leg down on the floor with the knee straight.
2. The same may be done standing.
3. Repeat with the other leg.

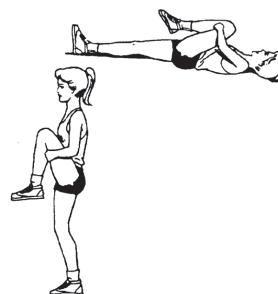

## Anterior Tibials (front of shin)

1. Stand with all of your weight on one leg. Extend the opposite leg forward and flex and point at the ankle.
2. Repeat with the other leg.

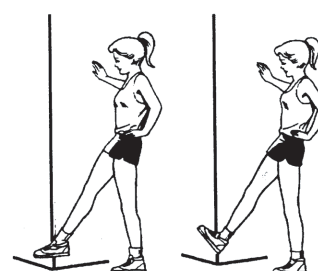

Here are some preventative maintenance tips that will keep your treadmill operating at its best.

## Cleaning

When cleaning the exterior of the unit, a non-abrasive cleanser and soft cotton cloth are strongly recommended. At no time should cleanser be applied directly to any part of the equipment. Instead, place the non-abrasive cleaning solution on a soft cloth and wipe down the unit.

- Clean the console and all exterior surfaces regularly.
- Vacuum running belt regularly to keep debris from accumulating.
- Inspect exterior parts regularly for wear and tear. Especially the running belt and deck.
- Inspect area under treadmill and vacuum regularly.

## Recommended Maintenance

Item	Daily	Weekly	Monthly	Quarterly	Bi-annual
Console Mounting Bolts					Inspect
Frame	Clean				Inspect
Console	Clean		Inspect		
Safety Stop	Test				
Power Cord			Inspect		
Running Belt Top		Clean (Vacuum)			
Running Belt Tension			Inspect		
Running Belt				Inspect	
Rear Adjustable foot				Adjust	
V Belt				Adjust	Inspect
Motor Pulley				Clean	

1. The Warranty applies to the original owner and is extended to cover the cost of part(s) repair and/or replacement and does not include associated freight charges. Proof of purchase must be demonstrated.
2. This warranty applies to residential use only, and is void if this product is used in a non-residential environment.
3. Warranty is non transferable. The warranty card must be completed and sent back to Fitness Master Inc., to complete registration.
4. Labor is covered for period of one year from date of sale.
5. Labor coverage is provided only if an authorized Fitnex dealer or the Fitnex factory representative does the work.
6. Any reimbursement for travel outside of the dealers' normal service or coverage area will be the responsibility of the customer.
7. Warranty does not cover failure due to improper assembly, installation or use.
8. This warranty does not cover customer instruction, installation, set up or adjustment. Note that tread belt tensioning and tracking are the responsibility of the user and are not covered by this warranty. User is also responsible for reasonable and necessary maintenance. Failure to maintain proper tread belt tracking and tensioning will void this warranty.

9. This warranty will not be extended to any product whose serial number has been removed, altered, or defaced.
  
10. This warranty does not cover damage or equipment failure caused by, or resulting from accident, misuse, abuse, improper assembly or installation, un-authorized modification, or failure to provide reasonable and necessary care as outlined in the owner's manual.

This warranty becomes VALID ONLY if the Home-Use Warranty Registration form included in the box is completely filled in, signed by the original purchaser and mailed to Fitn~~e~~x WITHIN 30 DAYS of the purchaser's receipt of the treadmill.

**Please call FitDel  
512-687-3161  
For ANY service issues**

***FITNESS MASTER INC.***

11419 Mathis #200, Dallas, TX 75234

Tel:214-3508884 Fax:214-2508876

Toll Free:1-866-4fitnex

E-mail:info@fitnexusonline.com

<http://www.fmiamerica.com>

***JOONG CHENN INDUSTRY CO., LTD.***

3F28, No. 5, Shin-Yi Rd., Sec. 5, Taipei 110, Taiwan

Tel:886-2-2720-9980

Fax:886-2-2722-9750

E-mail:joong@ms13.hinet.net

<http://www.steelflexfitness.com>