

**CASC**  **DE**

HEALTH & FITNESS®

Cascade Power  
Owner's Manual



# Cascade Power™

CASCADE HEALTH AND FITNESS LLC

PO BOX 1318

WOODINVILLE WA 98072

PHONE: (425) 402-4062

FAX: (425) 402-4063

EMAIL: [info@cascadehealthandfitness.com](mailto:info@cascadehealthandfitness.com)

[www.cascadehealthandfitness.com](http://www.cascadehealthandfitness.com)

PLEASE KEEP THIS BOOKLET FOR IMPORTANT WARRANTY INFORMATION & FUTURE REFERENCE. PLEASE FILL IN BELOW CHART WITH REQUESTED INFORMATION FOR FUTURE USE:

MODEL NUMBER	37120-10
DATE OF PURCHASE	
SERIAL NUMBER	
DEALER NAME	
DEALER PHONE NUMBER	

## CONGRATULATIONS

You have just become a valued Cascade customer. Our team is committed to making your cycling experience fun and rewarding — offering you detailed product information, expert fitness advice, and direct customer support you can depend on. Thank you for purchasing the Cascade Power group cycle.

This **Cascade Power** Owner's Manual will help you get the most enjoyment from your new indoor group cycle. It not only explains all the important features and safety considerations of the **Cascade Power**, it also includes great workout tips and exercise principles. If at any time you have questions about this information, please call us at (425) 402-4062 and we will be happy to help you. To help us answer your questions quickly, we recommend that you have the serial number of your bike ready when you call us. The serial number of your bike is located on bike frame.

The **Cascade Power** has been built to deliver an incredible workout, every component of the **Cascade Power** has been designed to be more durable, more user friendly and more comfortable than any other indoor group cycle you have ridden. Whether you are a beginning fitness enthusiast or a highly conditioned athlete, you will immediately feel the difference.

### **Greater Comfort and Essential Feedback**

- 4-way handlebar & seat adjustability allows you to properly fit your bike.
- Narrower crank design for greater comfort.
- Power Display lets you train for top cycling performance – measuring your watts, heart rate, level of resistance, speed, cadence, calories, time and distance – to meet and improve your personal cycling goals.

Finally, its attractiveness and small footprint allows you to position the **Cascade Power** anywhere in your home/facility for maximum enjoyment; and you'll also enjoy how quiet a **Cascade Power** workout is. You will quickly discover that the **Cascade Power** gives you a better cycling experience than any other indoor group cycle.

## FEATURES

- ✓ **Smooth, quiet magnetic resistance** reduces maintenance and service
- ✓ **Power Console** – Essential feedback provided to meet your cycling goals – watts, heart rate, speed, rpms, calories, time, distance and level.
- ✓ **Durable frame design** — Excellent stability, and 350 lbs. user load
- ✓ **Extra strong bottom bracket design** — Fast, simple assembly and service
- ✓ **Sweat guard and fender** to keep sweat off flywheel and brake assembly
- ✓ **Wide adjustment range** — Better fit for tall and short users for improved comfort
- ✓ Complete bike designed for maximum **corrosion resistance**
- ✓ **Pop pin post clamps** — Quick and secure locking for easy vertical adjustment of the seat and handlebar
- ✓ **Dual sided pedals** — SPD on one side and standard pedal cage on other side
- ✓ **No calibration required** — Just hop on & ride
- ✓ **4-way micro adjustability** for both seat & handlebars allows you to find the perfect fit.
- ✓ **Left and right stretch pads** – for post rider stretching.
- ✓ **Wide cross legs** – for maximum stability
- ✓ **Large in-line wheels**– easy and quick to move bike
- ✓ **Two water bottle holders** – provides for plenty of water during long rides
- ✓ **Large diameter leveler feet** – allows you to make the bike stable on uneven surfaces
- ✓ The **Cascade Power** is so smooth and comfortable you can work out much longer than you ever imagined.

Please review the rest of this Owner's Manual carefully before you start using your new **Cascade Power**. The information enclosed here will help you get the most enjoyment out of your workout and includes valuable operating, service, safety, and troubleshooting information, as well as guidelines for an effective exercise program.

We are confident that you will love your new **Cascade Power**.

Enjoy your riding.

## INDEX

WARRANTY	PAGE 7
SAFETY INSTRUCTIONS/INFORMATION	PAGE 8
DELIVERY	PAGE 11
DIAGRAM	PAGE 12
UNPACKING INSTRUCTIONS	PAGE 13
ASSEMBLY INSTRUCTIONS	PAGE 15
OPERATING INSTRUCTIONS	PAGE 18
GUIDELINES FOR SAFE OPERATION	PAGE 19
BASIC OPERATION	PAGE 23
POWER CONSOLE	PAGE 24
GENERAL EXERCISE GUIDELINES	PAGE 26
MAINTENANCE INSTRUCTIONS	PAGE 28
TROUBLESHOOTING	PAGE 30
SPECIFICATIONS	PAGE 32
EXERCISE LOG	PAGE 34

## WARRANTY

PARTS		LABOR
FRAME	LIFETIME	1 YEAR FOLLOWING CUSTOMER INSTALLATION
NON WEARABLE PARTS	5 YEARS	
ELECTRONICS	2 YEAR	
PEDALS	2 YEAR	
WEARABLES	2 YEAR	

**NEED ASSISTANCE? Customer Service: (425) 402-4062**

**Prior to contacting our Customer Service Department, please have the following information:**

- Your name, Customer Number, Shipping Address & Telephone Number
- Serial Number(s) of the inoperable bike(s)
- Date(s) of Purchase for the inoperable bike(s)
- Your Billing Address

The above information will ensure that you are the only one ordering parts under your warranty protection. If warranty replacement parts are shipped to you, you may be required to return the inoperable part(s). To facilitate this process, the following policy has been established:

- Contact our **Customer Service Department** to receive a **Return Authorization #** prior to shipment
- Cascade will incur all UPS Ground freight charges for Warranty Parts ordered for a machine that is less than 90 days old. You are responsible for freight charges on warranty parts for machines that are more than 90 days old. You will not be responsible for freight charges for any returned inoperable parts.
- If an inoperable warranty part(s) must be returned to our Customer Service Department, we will pay the shipping cost and provide detailed return shipping instructions. These instructions will be sent along with your warranty replacement part(s)



## WARNING

When present, this symbol is an indicator that you should proceed cautiously and be alert as your safety is dependent on your attention to the instructions.

When present, this statement is an indication that there are potential hazards that could result in injury or death.

### **PRIOR TO BEGINNING AN EXERCISE PROGRAM, READ ALL INSTRUCTIONS CONTAINED WITHIN THIS DOCUMENT**

1. The Cascade Power Indoor Group Cycle is intended for cardiovascular fitness training and may be used in group or individual settings.
  - a. Use this equipment only for its intended use as described in this manual
  - b. Do not attempt to ride this bike at high pedal speeds or in a standing position until you have practiced and are comfortable riding at slower pedal speeds.
2. This unit is NOT equipped with a freewheel system. If the flywheel is in motion, the pedals will be in motion.
  - a. Do not attempt to stop the unit by applying reverse pressure to the pedals as knee injury may occur.
3. Do not attempt to remove your feet from the pedals while they are in motion as serious injury may occur from the spinning pedals.
4. Wait for the flywheel to coast to a stop.
  - a. If you want to quickly stop the flywheel, push the lever down. Do not attempt to dismount the Cascade Power unless the pedals and the flywheel are at a complete stop.



5. Injury or death may occur from improper use or over-training. Consult a medical doctor or qualified fitness instructor to determine an exercise program appropriate to your level of fitness.
6. Never attempt to turn the pedal crank arms by hand.
  - a. Do not expose ANY part of your body or clothing to the drive mechanism as possible injury could occur.
7. In commercial settings, the Cascade Power should always be used in a supervised environment with qualified instructors.
8. In a home setting, keep unsupervised children away from the unit when not in use.
  - a. Keep children and pets away from the unit while in use.
9. Do not perform push-up type movements on the handlebars.
10. Never drop or insert any object into any opening on the exercise equipment.
11. Only use the unit on a stable, level floor.
12. Follow the instructions for safe use of the equipment including proper seat position, handlebar position, and use of the foot positioning system of the pedals. Never adjust the handlebar height higher than maximum height which is marked with the word "MAX".
13. For safe operation, allow for at least 1 foot (30cm) of free space to either side of the unit and 2 feet (60cm) of free space to the rear and front of the unit.
14. DO NOT attempt to make any handlebar or seat adjustments while sitting or standing on the bike.
15. Users, agents, and anyone directing the use of this equipment shall be responsible for determining the suitability of the product for its intended use as outlined in this manual, including regular maintenance tasks.

Said parties are put on notice that they assume all risk and liability in connection herewith.

16. Rider capacity of the Cascade Power is 350 lbs (159 kg).

The safety level of this equipment can only be maintained by following the guidelines in this manual and examining the equipment regularly for damage and wear.

Damaged or inoperable components should be replaced immediately and the equipment should not be used until it is repaired.

Failure to follow all guidelines above may compromise your exercise experience, expose you and others to injury, and reduce the longevity of the equipment.

## DELIVERY

Upon delivery of your Cascade Power, take a moment to check the box exterior for any damage and make a note of it on the delivery receipt before signing. Make your delivery agent aware of any concerns you have and that they have been denoted on the delivery receipt. Please contact our Customer Service department (425)402-4062 if there are issues.

Your Cascade Power will arrive in (1) carton and will require some assembly. What's Inside the Box:

Bike Frame with Flywheel

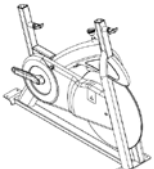

Pedal, Left



Pedal, Right



Seat/seat slider

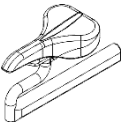

Seat Post



Water bottle holders (2)

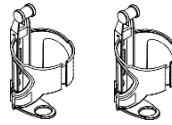

Handlebar

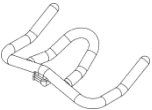

Handlebar Post



Adjustment handle



Square washer



Front Cross leg

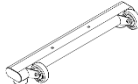

Rear Cross leg



Screw, washer (4)(M5)



Screw, nut, washer (4)(M8)



Console w/batteries



Console, Clamp



HR Monitor



Tools for assembly - two hex wrenches and multi tool

# DIAGRAM

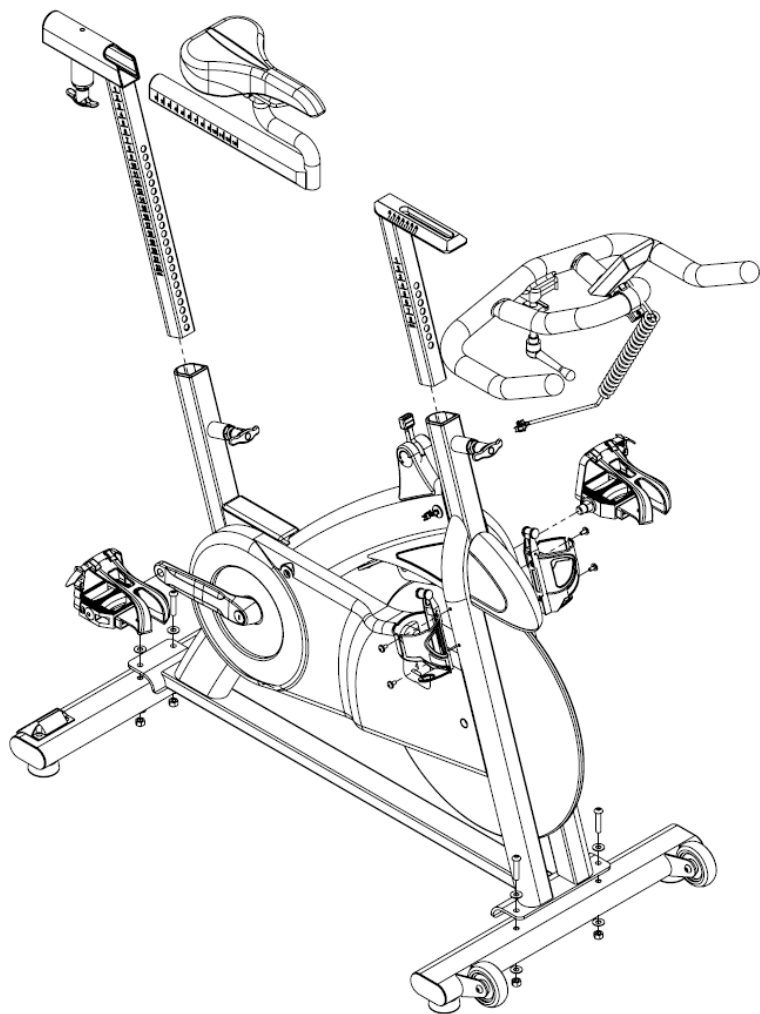

## UNPACKING INSTRUCTIONS

Before leaving the manufacturing facility, your Cascade Power exercise bike was thoroughly inspected and tested for proper operation. To minimize shipping damage, careful attention was given to making your bike ready for shipment.

Prior to opening the box, place it in the room of use where there is a large, clear area in order to facilitate an easy assembly.

- 1) With the box in upright position, remove the strapping material. Next remove the staples on the top of the carton.
- 2) Open the carton from the top of the carton.



- 3) Remove the seat assembly and the foam piece in the center of the carton.



- 4) Remove the handlebars.
- 5) Carefully lay the carton on its side and pull out the bike frame and foam supports from inside the carton.



## UNPACKING INSTRUCTIONS

- 6) Stand up the frame and foam supports, then remove the foam pieces from each end of the bike frame.



- 7) Remove all the parts/pieces from the foam supports. You should have:
  - a. An Owner's Manual
  - b. All the parts required to assemble the Cascade Power
  - c. All the necessary tools to assemble the Cascade Power

### STABILIZERS/ HANDLEBAR POST AND HANDLEBAR ASSEMBLY

- 1) Align the front stabilizer (the one with the transport wheels) with the holes in the main frame, below the flywheel.
- 2) Attach the stabilizer with (2) M8x60mm screws and (4) Washers(two on top of frame and two on bottom of stabilizer).
- 3) Tighten with the provided Hex key and multi tool.
- 4) Attach the handlebar to the handlebar post using the included adjustment handle and square washer. The simplest way to do this is put the handlebar on the ground upside down and then place the handlebar post over the handlebar and attach using the adjustment handle and square washer(make sure the square washer is on the adjustment handle with the smaller side facing the handlebars) and tighten.
- 5) Loosen and then pull the T handle on the frame while inserting the handlebar post and handlebar into the front frame opening. Tighten the T handle.
- 6) Standing in front of the bike, grab the handlebars and tip the bike forward and rest the handlebars on the ground. Be careful not to let the frame fall over to either side.
- 7) Align the rear stabilizer (the one with the stretch pads) with holes in the main frame as shown

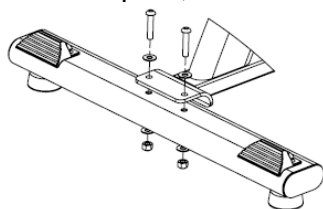
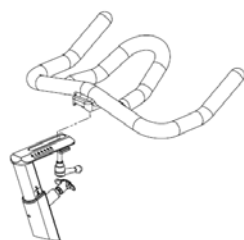
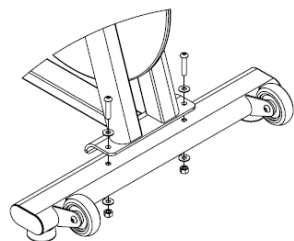

- 8) Attach the stabilizer with (2) M8x60mm screws and (4) Washers(two on top of frame and two on bottom of stabilizer)

## ASSEMBLY INSTRUCTIONS

- 9) Tighten with the provided Hex key and multi tool.

### SEAT POST AND SEAT ASSEMBLY

- 1) Loosen and then pull the T handle on the frame while inserting the seat post as shown. Tighten the T handle.
- 2) Loosen and then pull down the T handle on the seat post while inserting the seat slider assembly as shown. Tighten the T handle.

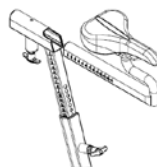

### PEDALS

- 1) The pedals are marked as if you are seated on the bike, "R" for right, and "L" for left
- 2) Carefully thread the right pedal into the crank arm with your fingers – **do not cross thread the pedal in the crank arm!**
- 3) Use the wrench tool to strongly tighten the pedal. Torque pedals to 47 Nm (35 ft-lb)
- 4) Repeat this step for the left pedal – **NOTE: The LEFT PEDAL is REVERSE THREADED**

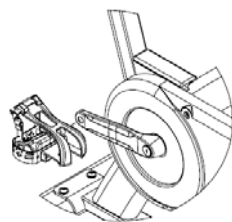

### WATER BOTTLE HOLDERS

- 1) To install the water bottle holders to the side of the frame near the flywheel, insert the two screws with washers as shown.
- 2) Tighten the screws with a Hex key to secure the holders to the frame.

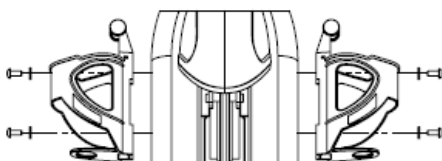



### INSTALLING POWER DISPLAY

- 1) Install the provided batteries into the back of the display.
- 2) Attach the clamp to the back of the console plate
- 3) Attach the console plate with clamp to the back of the console
- 4) Place lower clamp under handlebar to meet with console plate clamp and screw together so clamps fit snugly together



- 5) Connect the ends of the display cables with the connectors

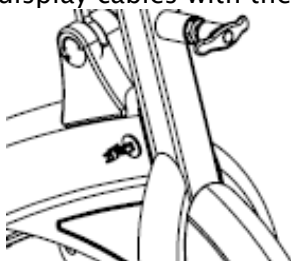

on the side of the frame.

- 6) Carefully remove the wire plug from the frame, push the connectors into the frame and re-insert the wire plug into the frame.



## WARNING

THESE GUIDELINES ARE DIRECTED TO YOU, AS THE OWNER OF THIS EXERCISE EQUIPMENT. YOU SHOULD INSIST THAT ALL USERS FOLLOW THE SAME GUIDELINES. YOU SHOULD MAKE THIS MANUAL AVAILABLE TO ALL USERS.

- 1) Obtain a complete physical examination from your medical doctor and enlist a health/fitness professional's aid in developing an exercise program suitable for your current health status.
- 2) When working out for the first time, start out slowly for a minimum of five minutes. After your muscles are warmed up, gradually increase the pedaling rate and/or resistance to a speed that allows you to attain your target heart rate zone.
- 3) The speed and duration of your exercise program should always be subject to how you feel. Never permit peer pressure to exceed your personal judgment while exercising.
- 4) Overweight or severely unconditioned individuals should be particularly cautious when using the equipment for the first time. Even though such individuals may not have histories of serious physical problems, they may perceive the exercise to be far less intense than it really is, resulting in the possibility of overexertion or injury.
- 5) Although all equipment manufactured by Cascade Health and Fitness has been thoroughly inspected by the manufacturing facility prior to shipment, proper installation and regular maintenance are required to ensure safety. Maintenance is the sole responsibility of the owner.

### ADJUSTING THE FIT

Take a moment to learn how to properly fit your Cascade Power to your body; it will make your workouts a more pleasant and safer experience.

The Cascade Power provides more seat and handlebar adjustability than other indoor group cycles, and each adjustment is numbered so you can quickly return the adjustments to your specific settings.

Making full use of these features will give you the most comfortable ride possible and allow you to exercise efficiently. Using the bike when it is incorrectly adjusted can result in unnecessary discomfort and increase your risk of injury.



### WARNING

DO NOT ATTEMPT TO MAKE ANY ADJUSTMENTS TO THIS EQUIPMENT WHILE SITTING OR STANDING ON THE BIKE. DISMOUNT THE BIKE PRIOR TO MAKING ALL ADJUSTMENTS.

### SEAT ADJUSTMENT

#### Adjusting the Seat Height

- 1) Stand next to the Seat Post and adjust the seat to Hip height
- 2) Rotate the crank so that the pedals are in the vertical position (12 & 6 o'clock)
- 3) Place your foot in the toe cage of the pedal closest to the floor and mount the bike
- 4) With one pedal at the 6 o'clock position you should just be able to scrape the bottom of your heel on the top of the pedal - this will allow for a slight bent to your knee when pedaling.



- a) If your leg is too straight or your foot cannot touch the pedal, you will need to lower the seat
  - b) If your leg is too bent, you will need to raise the seat
- 6) Dismount the bike and pull out the pop pin on the seat post
  - 7) Slide the seat post up or down as necessary
  - 8) When the seat is in the desired position, insert the pin into the desired hole to secure the seat post and tighten the T handle
  - 9) Make note of the final position mark on the seat post for future reference

### ADJUSTING THE SEAT'S FORE/AFT POSITION

- 1) Sit on your bike with the cranks in the 3 & 9 o'clock positions. A proper fore/aft position of the seat is achieved when the small bump at the top of the shin on your forward leg, directly below the knee cap (tibial tuberosity), is above the pedal axle



- 2) Dismount to adjust the seat fore or aft for a better fit
- 3) Loosen the seat adjustment lever and slide the seat forward or backward as desired; then tighten.
- 4) Note the final position mark under the seat for future reference. (Repeat steps for seat height if necessary)

### HANDLEBAR ADJUSTMENT

#### Adjusting the Handlebar height

- 1) Handlebar height is matter of preference. Start with the handlebars at the same height as the seat.
- 2) Adjusting the handlebars higher will give the rider a more upright position; lowering them will result in a more prone position.
- 3) Dismount the bike and pull out the pop pin on the handlebar post.
- 4) Raise or lower the handlebar by pulling up on the handlebar and sliding the handlebar post up or down as desired. When the handlebar is in the desired position, insert the pin into the desired hole to secure the seat post and tighten the T handle
- 5) Note the final position mark on the handlebar post for future reference.

## GUIDELINES FOR SAFE OPERATION

### Adjusting the handlebar's Fore/Aft Position

- 1) Dismount the bike and loosen the handlebar forward/aft adjustment lever and slide the handlebars either forward or aft as desired. The forward/aft position should be set to allow the rider to comfortably grasp the handlebars with a slight bend at the elbow.
- 2) Tighten the adjustment lever clockwise to secure the handlebar assembly. (Remember to use the ratchet feature of the adjustment lever as necessary)
- 3) Note the final position mark for future reference

### Pedal Strap Adjustment

- 1) Place the ball of each foot on the pedal and in the toe cage such that the ball of the foot is centered over the pedal spindle and under the strap
- 2) Rotate the cranks until one foot is in a position closest to you
- 3) To tighten the strap, pull up on the end of the strap until it fits snugly over your shoe. Make sure that the strap is secure, but not overly tight or pressing uncomfortably on your foot.
- 4) Repeat for the other foot
- 5) To loosen the pedal strap, press down on the clip that holds the strap secure, and pull slightly outward
- 6) Release the clip to lock the strap into place

Now that you have established a riding position, take a few minutes to ride the bike and determine that your position is comfortable. Start pedaling at a slow pace with your toes and knees pointed directly forward. Hold the grips lightly and in a position that allows your shoulders and upper body to relax. Pedal easily, at a low resistance, until you feel confident that you could ride in that position for the duration of your workout.



## WARNING

IF AT ANY TIME DURING YOUR WORKOUT, YOU FEEL CHEST PAIN, EXPERIENCE SEVERE MUSCULAR DISCOMFORT, FEEL FAINT, OR ARE SHORT OF BREATH, STOP EXERCISING IMMEDIATELY. IF THE CONDITION PERSISTS, YOU SHOULD CONSULT YOUR MEDICAL DOCTOR IMMEDIATELY.

- 1) Pedaling resistance is controlled by the red lever located beneath the handlebar, on the main part of the frame. Resistance may be changed at any time by moving the lever down for more resistance, or up for less resistance
- 2) To apply the brake, move the lever down
- 3) Before dismounting, apply the brake to stop the flywheel, or increase the resistance and let the flywheel come to a stop
- 4) To dismount the bike, first loosen each toe cage strap and remove your feet from the pedals, then step off the bike

## POWER DISPLAY

**NOTE:** Prior to using your console, you must calibrate the resistance levels with your bike. Please refer to the Console instructions included in the console box to calibrate the resistance levels with your bike.

**TURN ON THE CONSOLE** by pressing any key—the console will standby (no movement—all zeros) until you press **START/STOP** or make another selection

### TURN OFF THE CONSOLE

If you haven't starting working out:

- Press the **POWER** key (it will turn off after 3 minutes if there is no activity/selection)

If you stopped exercising and the console is still running:

- **TURN OFF** the console by pressing the **START/STOP** key (to pause) and then the **POWER** key

### KEY INFORMATION

- **AVG/MAX:** press this key during your workout and the console will to switch between Average and Maximum values for RPM, WATTS, Heartrate and Speed
- **START/STOP:** press this key and the console will start/stop reporting data. Press it in the middle of exercising and it will pause your workout
- **BACK LIGHT:** press this key to turn on/off the console light -default for backlight on is 10 seconds

**NOTE:** Once you turn on your console and press the **START/STOP** key, your time has begun.

- If you do not begin your workout within 30 seconds, the console will pause (blinking) for 60 seconds.
- After 60 seconds on pause, the console will stop blinking and standby for another 15 seconds before resetting to zero and turning off

### PAUSE YOUR WORKOUT

If you need to take a break, you can pause the console by pressing the **START/STOP** key.

- If you stop working out for 60 seconds, the console will temporarily pause (blinking). During this time:
  - Start pedaling within 2 minutes & your workout will continue
  - After 2 minutes on pause, the console will turn off
  - If you press & hold the **START/STOP** key for 2 seconds the console data will reset to 0
  - If you press the **POWER** key for 1 second, the console will turn off



## **READY TO EXERCISE**

### **START YOUR WORKOUT**

- press **START/STOP** key. The console will begin timing & reporting your activity

### **PAUSE YOUR WORKOUT**

- press **START/STOP** key

### **RESTART YOUR WORKOUT**

- press **START/STOP** key before workout has been paused for 2 minutes or begin pedaling

### **RESET/CLEAR DATA**

- press **START/STOP** key once to pause the workout, then press & hold down the **START/STOP** key until it clears to zero

### **TO USE BACK LIGHT**

- press the **BACK LIGHT** key

### **TO SWITCH BETWEEN AVG/MAX for RPM, Speed, Heartrate and WATTS**

- press the **AVG/MAX** key

### SETTING A GOAL

The first step to a successful exercise program is to set realistic goals and objectives. Do you want an exercise program that is geared to build muscle, maintain muscle tone, increase aerobic capacity, or lose weight? In order to ensure that you fully receive all the benefits of a sound exercise program, you need to first identify the existence (if any) of risk factors that may influence the design of your exercise program. Based upon a comprehensive analysis of your personal exercise needs and interests, you should then develop (or have developed for you by a competent or trained professional) an individualized program of exercise that is enjoyable, easy, and yet challenging. Your greatest health benefit will come from a lifestyle change that encourages a lifetime of physical activity.

One way to guarantee success in reaching your goal is to eat correctly. A well-rounded diet provides the proteins, carbohydrates, fats, vitamins, minerals, and water necessary for good health. If you are unsure of your dietary needs, seek the advice of your physician, an exercise professional, or visit your local bookstore for more information on nutrition.

### Flexibility Training<sup>1</sup>

Achieving and maintaining an adequate range of motion should always be objectives of a comprehensive exercise program. The warm-up phase of your exercise session should include some type of light warm-up activity to increase both your heart rate and your body temperature, which is then followed by flexibility exercises that are specifically designed to stretch the musculature around your body's major skeletal joints. Attempting to stretch a cold muscle can be dangerous to the soft tissues surrounding the muscle. No matter how controlled the movement, forcing a muscle through a full range of motion (and beyond) without appropriately warming up is both unsafe and counterproductive.

## GENERAL EXERCISE GUIDELINES

A general exercise program for achieving and maintaining flexibility should adhere to the following guidelines:

Frequency	Daily
Intensity	To a position of mild discomfort
Duration	10–30 seconds for each stretch
Repetitions	2–6 for each stretch
Type	Static, with a major emphasis on the low back and hamstrings area because of the high prevalence of low-back pain syndrome in our society

### Exercise Principles<sup>1</sup>

The American College of Sports Medicine has developed a position paper concerning exercise programs for healthy adults and the need for guidelines. The following recommendations concern the quantity and quality of (exercise) training for developing and maintaining cardiovascular fitness in a healthy adult:

Frequency	3–5 days per week
Intensity	50% – 85% of maximum oxygen uptake (VO <sub>2</sub> max)
Duration	20 to 60 minutes of continuous aerobic activity
Mode of Activity	Any activity that uses the large muscle groups, that can be maintained continuously, and is rhythmical and aerobic in nature
Rate of Progression	
Initial Conditions	4–6 weeks: low end intensity (40% – 60% VO <sub>2</sub> max)
Improvement Stage	6 weeks to 6 months: moderate intensity, moderate duration

<sup>1</sup> Some of the material contained in this section was adapted from “The StairMaster® Fitness Handbook, 2nd Ed”, by James A. Peterson and Cedric X. Bryant (editors), Sagamore Publishing, 1995.

## MAINTENANCE INSTRUCTIONS

### Helpful Hints

The safety level given by the design of this equipment can only be maintained when the equipment is regularly examined for damage and wear. Inoperable components should be replaced immediately or the equipment should be put out of use until it is repaired. Read all maintenance instructions thoroughly before beginning work.

All references to the right or left side and to the front or back are made as if you were on the exercise equipment ready to exercise. For example, the belt is on the right side of the bike.

### INITIAL SERVICE

Upon receiving your equipment, use a soft clean cloth to wipe off the dust that may have accumulated during shipping. Your equipment will need minor assembly. Refer to the “Assembly Instructions” section of this manual for details.

### MAINTANCE SCHEDULE

Part	Recommended Action	Frequency	Cleaner <sup>2</sup>	Lubricant <sup>2</sup>
Pedals <sup>1</sup>	Ensure that the pedals are tight in crank arms and not cross- threaded, all screws on pedals are tight, and pedal straps are not frayed	Before each use	N/A	N/A

**⚠️WARNING:** WHEN USED IN A CLUB SETTING IT IS CRITICAL THAT THE PEDALS BE CHECKED AFTER EACH CLASS TO ENSURE PROPER INSTALLATION. FAILURE TO DO SO MAY RESULT IN PROPERTY DAMAGE AND/OR RIDER INJURY. TORQUE PEDALS TO 47 Nm (35 FT-LB)

Frame	Wipe down	Daily	Soap & water; or, diluted non-abrasive cleaning solution	N/A
Flywheel	Wipe down	Weekly	WD-40® spray. Spray on rag & apply light coat to sides of flywheel.	N/A
Crank Bolts	Inspect for looseness	Weekly	N/A	If loose, remove bolt, apply Loctite® 242 on bolt threads and reinstall. Tighten to 48 ft-lbs or 575 in-lbs
Belt	Inspect for correct tension; replace cracked, frayed, or otherwise non-uniform belt	Monthly	N/A	N/A

<sup>1</sup>Cascade does not recommend attempting to service the internal parts of the pedals. If pedals are internally worn it is recommended that they be replaced.

<sup>2</sup>Use of lubricants or cleaning solutions other than those so specified will result in diminished performance and a shorter life span for that part.

### **SYMPTOM: SEAT OR HANDLEBAR POST MOVE AFTER LOCKED INTO POSITION**

- 1) Make sure the T handle is tightened.

### **SYMPTOM: CLICKING NOISE WITH EACH PEDAL REVOLUTION**

- 1) Check shoelaces to make sure the aglet is not tapping the bike as the pedals turn
- 2) Assure pedal straps are tight and that no excess strap on inner part of pedal is catching on the crank arm as it turns
- 3) Assure that pedals are tight on crank arms

### **SYMPTOM: CLICKING NOISE WHEN FLYWHEEL ROTATES**

- 1) Check for noisy flywheel bearings.
- 2) If flywheel bearings are noisy or rough have authorized service technician replace flywheel hub assembly.

### **SYMPTOM: DRIVE BELT IS SLIPPING**

- 1) Remove small access cover on belt cover

**Note:** Use caution around belt when cover is removed

- 2) Loosen idler and tighten tensioner bolt 2–3 turns with hex wrench
- 3) Tighten idler and test belt
- 4) If belt still slips repeat process until belt no longer slips
- 5) Reinstall small access cover on belt cover

### **SYMPTOM: KNOCKING NOISE OR PLAY FELT IN PEDALS/CRANKS**

- 1) Make sure pedals are tight on crank arms
- 2) Make sure crank bolts are tight. If loose, apply blue Loctite 242 to threads and tighten crank bolts with 8mm hex wrench
- 3) If problem persists check the bottom bracket for looseness.
- 4) If bottom bracket is loose contact authorized service technician for replacement of bottom bracket bearings.

### **SYMPTOM: ROCKING OR MOVEMENT FROM CASCADE POWER WHILE IN USE**

- 1) Using a hex wrench, check the attachment bolts on the front and rear stabilizers and make sure they are tight (2 bolts on each stabilizer)
- 2) Assure the bike is level by checking the leveling feet on the bottom of the front and rear stabilizers

### **SYMPTOM: LCD ONLY SHOWS PARTIAL DISPLAY**

- 1) Remove the batteries and wait 15 seconds and then reinstall the batteries.

## SPECIFICATIONS

### PHYSICAL DIMENSIONS

- Length: 42 in (107 cm)
- Height: 42 in (107 cm)
- Width: 23in (59 cm)
- Weight: 96 lbs (44 kgs)

### SHIPPING CARTON DIMENSIONS

- Length: 45in (114 cm)
- Height: 38 in (96.5cm)
- Width: 12 in (30.5 cm)
- Weight: 110 lbs (50 kg)

### FRAME

- ED and Powder Coated Finish
- 23 inch wide base with large diameter adjustable levelers

### FLYWHEEL

- Precision Anodized Aluminum Machined Flywheel

### BRAKING AND RESISTANCE MECHANISM

- Lever – 16 levels of resistance
- Magnetic Resistance

### CRANK SET

- Forged Cranks (170 mm)
- Oversized and hardened Cr-Moly bracket spindle
- Press fit style bottom bracket with oversized bearings



## SPECIFICATIONS

### HANDLEBARS

- Biomechanically correct with anatomical bend
- Adjustable up/down and fore/aft
- Over molded grip for greater comfort
- Adjustment marks for up/down and fore/aft adjustments

### STRETCH PADS

- Foot pads on base of rear stabilizer for stretching

### SEAT

- Seat slider allows for extended fore/aft adjustment
- Adjustment marks for up/down and fore/aft

### TRANSPORTATION WHEELS

- Extra Large In-Line skate wheels

### DRIVE TRAIN

- Reinforced Poly-V Drive Belt
- Precision Drive Pulleys

# EXERCISE LOG

Week #:	Date	Distance	Calories	Time	Comments
Day					
Monday					
Tuesday					
Wednesday					
Thursday					
Friday					
Saturday					
Sunday					
Weekly Totals					
Weekly Goals:					

# EXERCISE LOG

Week #:	Date	Distance	Calories	Time	Comments
Day					
Monday					
Tuesday					
Wednesday					
Thursday					
Friday					
Saturday					
Sunday					
Weekly Totals					
Weekly Goals:					

## EXERCISE LOG

Week #:					
Day	Date	Distance	Calories	Time	Comments
Monday					
Tuesday					
Wednesday					
Thursday					
Friday					
Saturday					
Sunday					
Weekly Totals					
Weekly Goals:					

CASCADE HEALTH AND FITNESS LLC

PO BOX 1318

WOODINVILLE WA 98072

PHONE: (425) 402-4062

FAX: (425) 402-4063

EMAIL: [info@cascadehealthandfitness.com](mailto:info@cascadehealthandfitness.com)

[www.cascadehealthandfitness.com](http://www.cascadehealthandfitness.com)