

**Fitnex**



**UPRIGHT BIKE / RECUMBENT BIKE / ELLIPTICAL**

---

**User Manual B/E/R:08**

Safety Instructions .....	1-2
Moving .....	3
Seat Adjustments.....	4
Leveling.....	5
XE5 Console & Feedback .....	6-8
30 Series Console & Feedback(B/E/R30) .....	9-13
55 Series Console & Feedback(B/E/R55SG) .....	14-25
70 Series Console & Feedback(B/E/R70) .....	26-33
Stretching and Flexibility.....	34-36
Maintenance.....	37
Warranty .....	38-39

**IMPORTANT SAFETY INSTRUCTIONS SAVE THESE INSTRUCTIONS**

When using an electrical product, follow basic precautions, including the following:

**WARNING!**

To reduce the risk of burns, fire, electrical shock or injury to persons:

- Use this exercise product for its intended use as described in this User Manual. Do not use attachments not recommended by the manufacturer.
- Never drop or insert any object into any opening.
- Do not remove the Upright Bike / Recumbent Bike / Elliptical side covers. Only an authorized FITNEX retailer should perform Service.
- Never operate this product if it has a damaged cord or plug, if it is not working properly, if it has been damaged, or immersed in water. Have equipment examined on required by an authorized FitnEX service provider.
- Do not use outdoors.
- When the FITNEX product is in use, young children and pets should be kept at least 10 feet away.
- Keep children off your FITNEX product at all times.

**SAFETY INSTRUCTIONS:****CAUTION!**

- If you experience chest pains, nausea, dizziness or shortness of breath, stop exercising immediately and consult your physician before continuing.
- Do not wear clothing that might catch on any part of the Fitnex product.
- Read this User Manual before operating this product.

**MOVING**

Your FITNEX product has a pair of transport wheels built into the front legs.

To move the FITNEX upright cycle, firmly grasp the handlebars, carefully tip toward you and roll on the transport wheels.

To move the FITNEX recumbent bike and elliptical, firmly grasp the rear foot assembly, carefully lift and roll on the transport wheels.

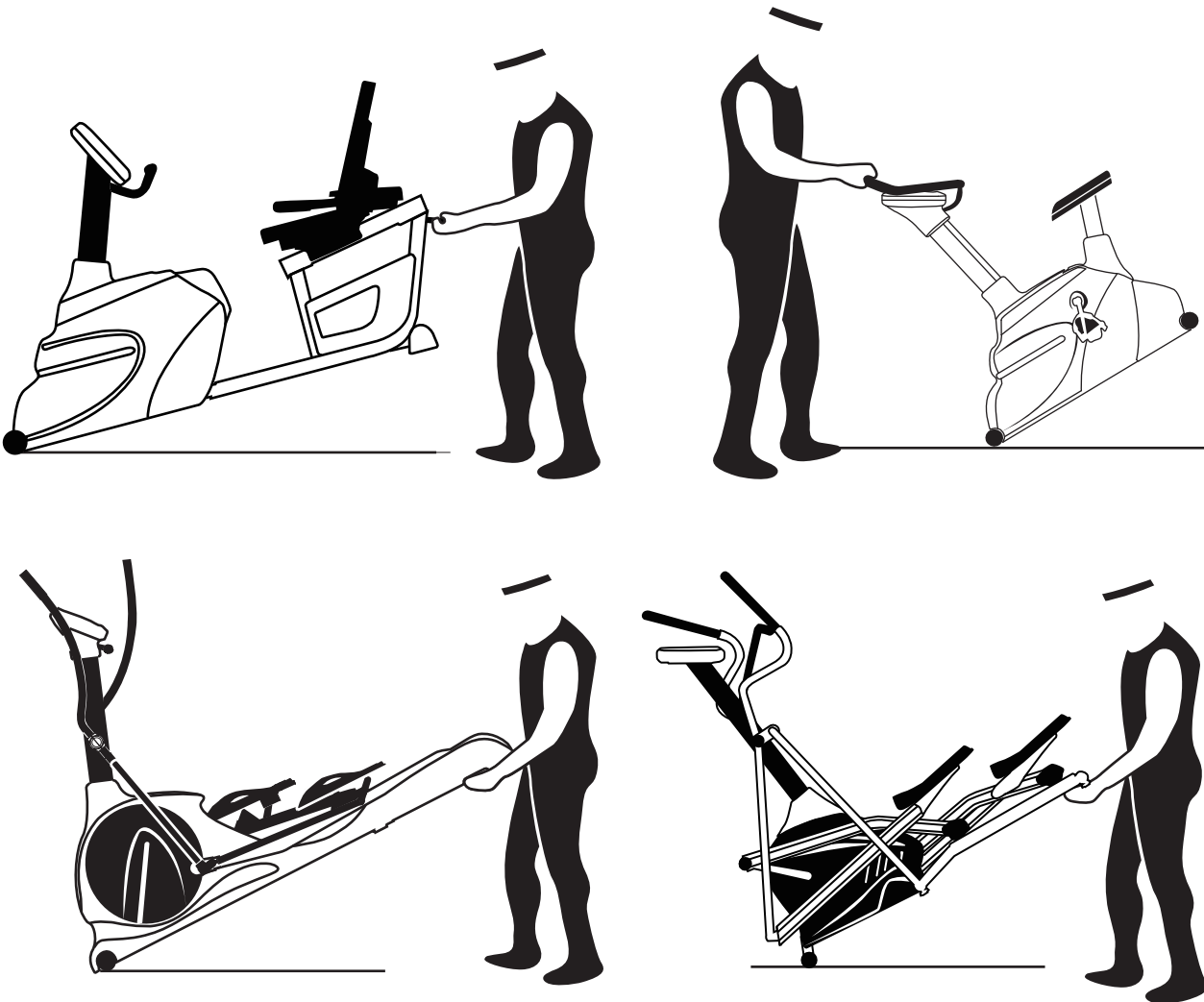

Caution: Our product is wellbuilt and heavy.  
Take caution and use additional help if necessary.

## SEAT POSITIONING

The seat of upright and recumbent bike is at the proper position when your knee is slightly bent when the pedal is in the furthest position.

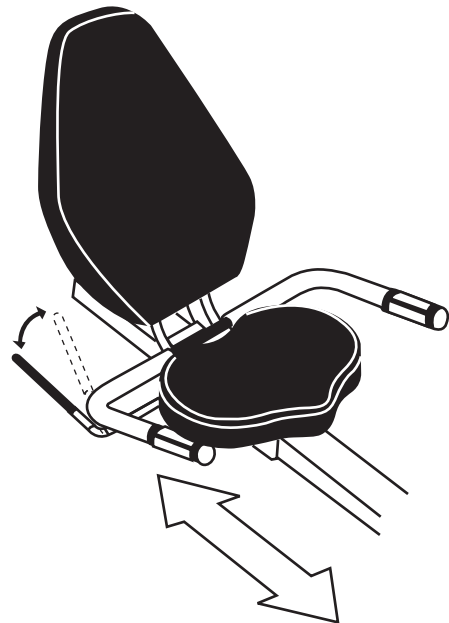
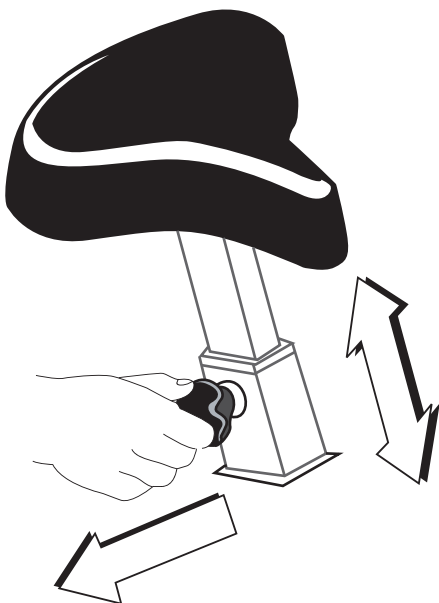

Grasp the Seat Adjustment Knob, located at the base of the seat post. Turn knob to loosen then pull out and raise or lower the seat post to the desired height. Release the knob and turn knob to tighten to allow the seat post to lock into position.

## LEVELING

The product should be leveled for optimum use. If your product wobbles when you have placed it where you intend to use it, raise or lower one or both of the adjustable levelers located on the bottom of the rear foot support. Once you have leveled the Recumbent bike, lock the levelers in place by tightening the screw against the rear foot support as well as the one located in the middle frame.

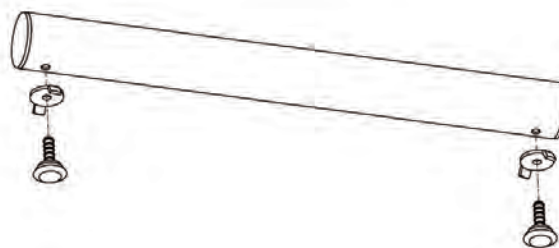
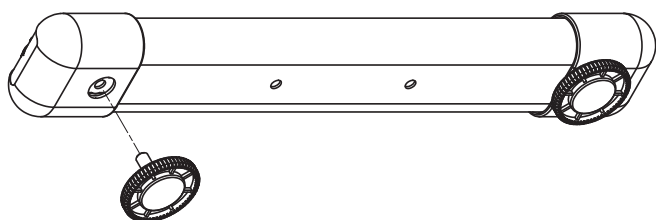
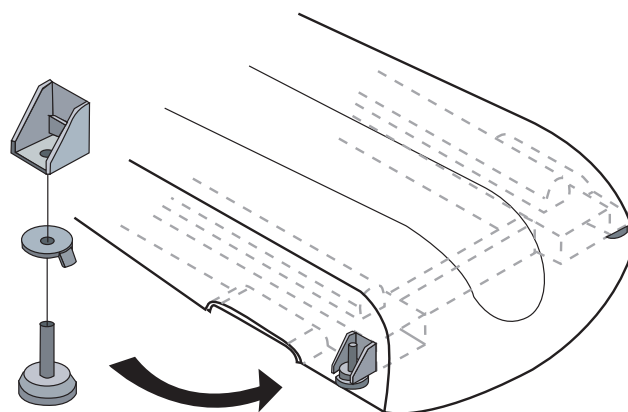
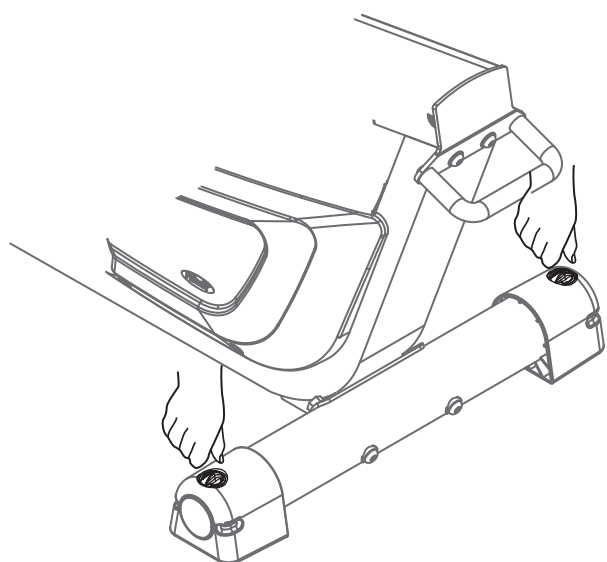

Note : adjust for leveling screws as necessary prior to use.







Function choice.  
For RESET to clean the value to be zero.

## DISPLAY INFORMATION

<b>SCAN</b>	Scans through each function values every 6 seconds.
<b>TIME</b>	View elapsed time in your workout. Displayed as Minutes:Seconds(0:00~00:59).
<b>SPEED</b>	Displayed as Miles per hour or kilometers per hour.
<b>DISTANCE</b>	Displayed as miles or kilometers. View distance traveled during a workout.
<b>CALORIES</b>	Displayed as estimates accumulated calories burned during workout.





**OPERATIONS**

<b>SCAN</b>	Press the button until SCAN appears on the screen. The computer automatically scans through each function value every 6 seconds on the display.
<b>TIME</b>	Press the button until TIME value appears on the LCD. The computer will display your actually workout time.
<b>SPEED</b>	Press the button until SPD appears on the LCD. The computer displays the current training speed.
<b>DISTANCE</b>	Press the button until DST appears on the LCD. The computer displays the accumulative distance traveled during workout.
<b>CALORIES</b>	Press the button until CAL appears on the LCD. The computer will display the total accumulated calories burned during workout.
<b>RESET</b>	Press and hold the button for 2 seconds to get the function value to be 0.
<b>AUTO ON/OFF</b>	When you start to exercise or press the button on the computer, it turns on. If you don't have any action or signal input to the computer for 4 minutes, the power will turn off automatically.

**NOTE**



Two batteries (SUM3 SIZE AA 1.5V) are used for this computer.





	Program selection.
	Increasing resistance or setting information.
	Decreasing resistance or setting information.
	Setting workout information.
	Shift watt and calories display.

In FitnEX 30 series products, there are 11 different exercise programs.

P1 ~ P6

step 1	Start pedaling.
step 2	Press “  ” to choose exercise program .
step 3	Press “  ” to set time, distance, calories, highest heart rate, lowest heart rate and age. After finishing setting, there is a pause of 6 seconds, then it will go back to exercising window by itself.

1. During workout, you can change resistance level by using

“  ” or “  ”.



2. The display will shut down after you stop pedaling three minutes.

Pedaling again or press any key, then it will display again.

3. You can change exercising program during your workout. When you change, time will count from 00:00, but calories and distance will keep accumulation.

4. You can also press “  ” and hold for 3 seconds, then time, distance and calories will become 0.



P7~P11 (All these programs are heart rate control modes.)

step 1	Start pedaling.
step 2	<p>Press “  ” to set time, distance, calories, highest heart rate, lowest heart rate and age.</p> <p>After finishing setting, there is a pause of 6 seconds, then it will go back to exercising window by itself.</p>
step 3	<p>Press “  ” to choose exercise program.</p> <p>P7: Max. heart rate is 50%. Target heart rate = <math>(220 - \text{age}) * 50\%</math></p> <p>P8: Max. heart rate is 60%. Target heart rate = <math>(220 - \text{age}) * 60\%</math></p> <p>P9: Max. heart rate is 75%. Target heart rate = <math>(220 - \text{age}) * 75\%</math></p> <p>P10: Max. heart rate is 85%. Target heart rate = <math>(220 - \text{age}) * 85\%</math></p> <p>P11: Max. heart rate is 95%. Target heart rate = <math>(220 - \text{age}) * 95\%</math></p>

I. All heart rate control programs are related to age, so please enter your age before choosing P7 to P11.







2. All exercising levels will be changed by your heart rate. If your heart rate is not 5 beats more or less than target heart rate, the resistance will not change. If the machine can not detect your heart rate, the resistance will not change.
3. The display will shut down after you stop pedaling three minutes. Pedaling again or press any key, then it will display again.
4. You can change exercising program during your workout. When you change, time will count from 00:00, but calories and distance will keep accumulation.
5. You can also press “  ” and hold for 3 seconds, then time, distance and calories will become 0.

#### Other tips:

1. Press and hold “  ” for three seconds, then you can change metric or english by pressing “  ” “  ”. After setting this, do not press any key for 6 seconds, and it will go back to exercising window.
2. If the batteries' power is not enough, it will show you battery icon on window. Please replace new batteries when you see this.

























	<p>Start, stop and reset the program.</p>
	<p>Enter selects.</p>
	<p>Shift display.</p>
	<p>Increase values.</p>
	<p>Decrease values.</p>
	<p>Starts pulse recovery.</p>
	<p>Wheel knob to adjust setting values or choose selects.</p>



















<b>TIME</b>	Indicates workout time.
<b>RPM/SPEED</b>	Indicates workout speed/RPM.
<b>DISTANCE</b>	Indicates workout distance.
<b>CALORIES</b>	Indicates workout calories.
<b>WATT</b>	Indicates workout watts.
<b>PULSE</b>	Indicates user's pulse during workout.
<b>RESISTANCE PROFILE</b>	Indicates resistance level by profile.

### MANUAL





<p>Step 1</p>	<p>Choose MANUAL in the beginning or press “  ”, then choose MANUAL. Press “  ”.</p>
<p>Step 2</p>	<p>Press “  ”, “  ” or “  ” to set distance, then press “  ”.</p>
<p>Step 3</p>	<p>Press “  ”, “  ” or “  ” to set calories, then press “  ”.</p>
<p>Step 4</p>	<p>Press “  ”, “  ” or “  ” to set time, then press “  ”.</p>
<p>Step 5</p>	<p>Press “  ”, “  ” or “  ” to set resistance level.</p>
<p>Step 6</p>	<p>Press “  ” to start workout.</p>



- Users might change resistance level by pressing “  ” and “  ” during the workout.
- Press “  ” during workout to pause. If user doesn't re-start in 30 seconds, it will enter sleep mode. If user recalls when the console is in sleep mode, it will enter mode screen.

### PRESET PROGRAM

<p>Step 1</p>	<p>Choose PROGRAM in the beginning or press “  ”, then choose PROGRAM. After choosing PROGRAM, press “  ”.</p>
<p>Step 2</p>	<p>Under PROGRAM, there are 12 different workout programs which are P1 to P12. Press “  ”, “  ” or “  ” to choose program, then press “  ”.</p>
<p>Step 3</p>	<p>Press “  ”, “  ” or “  ” to set distance, then press “  ”.</p>
<p>Step 4</p>	<p>Press “  ”, “  ” or “  ” to set calories, then press “  ”.</p>
<p>Step 5</p>	<p>Press “  ”, “  ” or “  ” to set set time, then press “  ”.</p>













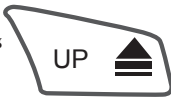

## PRESET PROGRAM

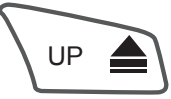
<p>Step 6</p>	<p>Press “  ”, “  ” or “  ” to set workout level.</p> <p>There are 8 workout levels which are L1 to L8.</p>
<p>Step 7</p>	<p>Press “  ” to start workout.</p>













1. Users might change resistance level by pressing “  ” and “  ” during the workout.

2. Press “  ” during workout to pause. If user doesn't re-start in 30 seconds, it will enter sleep mode. If user recalls when the console is in sleep mode, it will enter mode screen.

### H.R.C PROGRAM



















<p>Step 1</p>	<p>Choose HRC in the beginning or press “  ”, then choose HRC. Press “  ”.</p>
<p>Step 2</p>	<p>Press “  ”, “  ” or “  ” to choose gender, then press “  ”.</p>
<p>Step 3</p>	<p>Press “  ”, “  ” or “  ” to set target heart rate, then press “  ”.</p> <p>The way to calculate target heart rate:</p> <p>Target heart rate 55%: <math>(220 - \text{age}) * 55\%</math></p> <p>Target heart rate 75%: <math>(220 - \text{age}) * 75\%</math></p> <p>Target heart rate 95%: <math>(220 - \text{age}) * 95\%</math></p>
<p>Step 4</p>	<p>Press “  ”, “  ” or “  ” to set age, then press “  ”.</p>

## H.R.C PROGRAM

<p>Step 6</p>	<p>Press “  ”, “  ” or “  ” to choose distance, then press “  ”.</p>
<p>Step 7</p>	<p>Press “  ”, “  ” or “  ” to choose calories, then press “  ”.</p>
<p>Step 8</p>	<p>Press “  ”, “  ” or “  ” to choose time.</p>
<p>Step 9</p>	<p>Press “  ” to start workout.</p>





1. a. No change if 5 difference between heart rate value and target heart rate.
- b. If real HR is different from target HR over 5 but under 10, it will increase or decrease 1 resistance level every 15 seconds.
- c. If real HR is different from target HR over 10 but under 20, it will increase or decrease 2 resistance levels every 15 seconds.
- d. If real HR is different from target HR over 20, it will increase or decrease 3 resistance levels every 15 seconds.
2. Press “  ” during workout to pause. If user doesn't re-start in 30 seconds, it will enter sleep mode. If user recalls when the console is in sleep mode, it will enter mode screen.



### USER SETTING PROGRAM

<p>Step 1</p>	<p>Choose USER in the beginning or press “  ”, then choose USER. Press “  ”.</p>
<p>Step 2</p>	<p>Press “  ”, “  ” or “  ” to choose U1, U2, U3 or U4, then press “  ”.</p>
<p>Step 3</p>	<p>Press “  ”, “  ” or “  ” to set distance, then press “  ”.</p>
<p>Step 4</p>	<p>Press “  ”, “  ” or “  ” to set calories, then press “  ”.</p>
<p>Step 5</p>	<p>Press “  ”, “  ” or “  ” to set time, then press “  ”.</p>





















## USER SETTING PROGRAM

<p>Step 6</p>	<p>Press “  ”, “  ” or “  ” to set resistance level for each segment, then press “  ”.</p> <p>User can set up resistance levels for all 20 segments.</p>
<p>Step 7</p>	<p>Press “  ” to start workout.</p>

1. Users might change resistance level by pressing “  ” and “  ” during the workout. Once users change present resistance level, all other segments are also changed together.

2. Press “  ” during workout to pause. If user doesn't re-start in 30 seconds, it will enter sleep mode. If user recalls when the console is in sleep mode, it will enter mode screen.

## WATT CONTROL PROGRAM

Step 1	Choose WATT in the beginning or press “  ”, then choose WATT. Press “  ”.
Step 2	Press “  ”, “  ” or “  ” to set distance, then press “  ”.
Step 3	Press “  ”, “  ” or “  ” to set calories, then press “  ”.
Step 4	Press “  ”, “  ” or “  ” to set time, then press “  ”.
Step 5	Press “  ”, “  ” or “  ” to set watt.
Step 6	Press “  ” to start workout.

I. Press “  ” during workout to pause. If user doesn't re-start in 30 seconds, it will enter sleep mode. If user recalls when the console is in sleep mode, it will enter mode screen.



### Pulse Recovery

Step 1	Press “  ” after workout ends.
Step 2	Stop exercising.
Step 3	Ensure current heart rate is displayed.
Step 4	Sample test will take 1 minute, then result will display.

1. There are 6 "Fit" levels for heart rate recovery. The Numbers are for reference only, in order to indicate recovery rate / fitness condition. 6 / Slowest recover rate indicates improvement needed. This is a general sampling. True Fitness Condition Needs to be checked by your Doctor on a regular basis.

2. Regular exercise can help improve your cardiovascular condition.





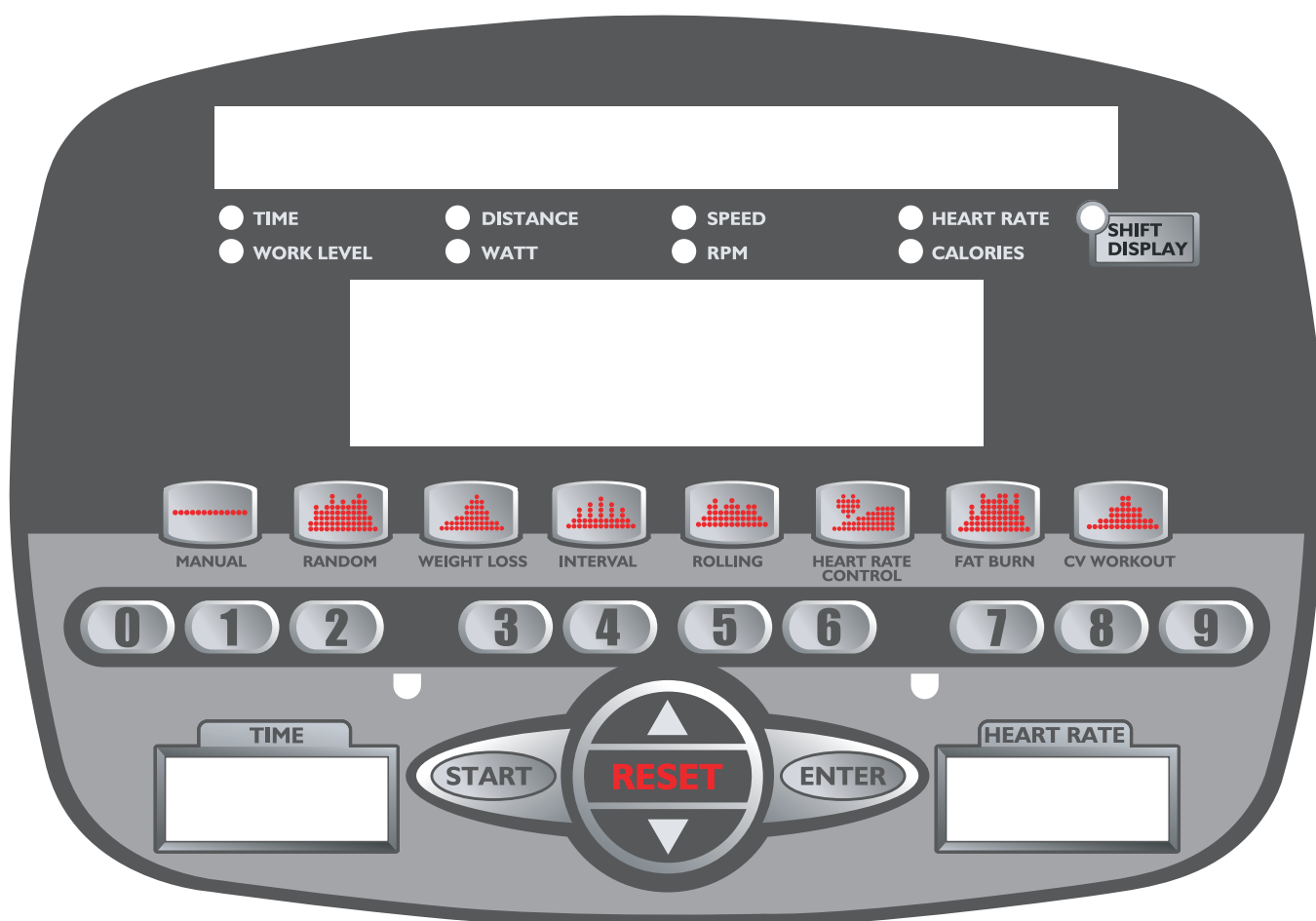

### ENGINEER MODE

Press “  ” to reset. Before beep voice stops, press “  ” and “  ” at the same time and hold until it enters engineer mode.

Users can press “  ” to choose KM or MILE. After setting,

press “  ” to leave engineer mode.

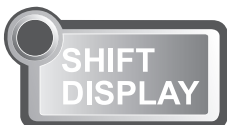



	<p>Begin workout. Move user from set up to exercise.</p>
	<p>Accept entry of variable setting.</p>
	<p>Increase/Decrease Level, Weight or Time</p>
	<p>Reset the workout information.</p>
	<p>Shift displayed group information between TIME/DISTANCE/RPM/HEART RATE and WORK LEVEL/WATT/METS/CALORIES.</p>
	<p>10-keypad adjusts variables during set up.</p>
	<p>Program selection</p>

<b>TIME</b>	View elapsed time in your workout. Displayed as Minutes: Seconds. Either count up 00:00 ~ 99:59 or count down 99:59 ~ 00:00.
<b>DISTANCE</b>	Displayed as miles or kilometers (00.00~99.99). View Distance traveled during a workout.
<b>SPEED</b>	Displayed as Miles per hour or kilometers per hour.
<b>HEART RATE</b>	Displayed as Beats per minute. Monitor your heart rate at any time during a workout.
<b>WORK LEVEL</b>	Indicates resistance selected from level 1 (easiest) to level 16 (hardest).
<b>WATT</b>	A measurement of your expended energy (000~250)
<b>RPM</b>	Displayed revolutions per minute.
<b>CALORIES</b>	Displayed as estimates accumulated calories burned during workout, based on weight, distance, workload and time.

### OPERATIONS



There are several programs designed in our 70 series products. You can start exercising by them.

### MANUAL











Step 1	Start pedaling.
Step 2	Press “  ” or “  ”



1. While exercising, you can press “  ” to change TIME/  
DISTANCE/SPEED/HEART RATE and WORK LEVEL/WATT/RPM/  
CALORIES information.

2. You can change your work level during exercising by press

“  ” or “  ” .















### INTERVAL/ CV WORKOUT/ WEIGHT LOSS/ RANDOM/ FAT BURN / ROLLING

Step 1	Start pedaling
Step 2	Choose one program you want to exercise then press the program button.
Step 3	Set level. There are 16 different levels. Please use “  ” or “  ” to change level, then press “  ”.
Step 4	Set weight. Please use “  ” or “  ” to change weight, then press “  ”.
Step 5	Set time. Please use “  ” or “  ” to change time, then press “  ”.
Step 6	Press “  ” to start your workout .

1. While exercising, you can press “  ” to change TIME/ DISTANCE/SPEED/HEART RATE and WORK LEVEL/WATT/RPM/ CALORIES information.
2. You can change your work level during exercising by press “  ” or “  ”.





### Heart rate control

Step 1	Start pedaling
Step 2	Press “  ”, then press “  ”.
Step 3	Choose one heart rate program you want to exercise. There are target HR, HR weight loss, HR fat burn, HR interval, HR rolling and HR hill.
Step 4	Set age. Please use “  ” and “  ” to adjust your age, then press “  ”.
Step 5	Set target heart rate. Please use “  ” and “  ” to adjust your target heart rate, then press “  ”.
Step 6	Set weight. Please use “  ” or “  ” to change weight, then press “  ”.
Step 7	Set time. Please use “  ” or “  ” to change time, then press “  ”.

## Heart rate control

Step 7

Press “  ” to start your workout.

1. While exercising, you can press “  ” to change TIME/  
DISTANCE/SPEED/HEART RATE and WORK LEVEL/WATT/RPM/  
CALORIES information.
2. You can change your work level during exercising by press  
“  ” or “  ”.
3. If the actual heart rate is lower than the target heart rate, the work  
level will be increased.

## 70 series cell phone recharge system



1. USB port: DC5V / 500mA (2.5W)  
Car-Charger port: DC12V / 300mA (3.6W)  
If both ports are in use, Max. Watts is (3.6W).
2. Use correct and suitable cable to connect your cell phone to the console ports.  
The Charger can be used 3 ways:
  - A. Charging a Cell Phone, iPod, etc., through the USB Port.
  - B. Charging a Cell Phone using the cell phone Car-Charger port.  
(Allows the rider to use their cell phone Car Charger cable system.)
  - C. iPod, etc., through the USB port and Cell phone through the Car-charger port, at the same time.
3. A minimum of 35RPM must be maintained to properly charge your device.

### Notice:

The Car-Charger port cap should be closed when not in use. Do not put your finger or other objects into the charger ports. Use only proper devices.

Adequate flexibility is the ability to move your limbs and joints easily (through a complete range of motion) the way you need to in order to meet the challenges of daily life. Fortunately there's a positive reinforcing cycle between flexibility and activity. Adequate flexibility enables you to maintain an active lifestyle, and an active lifestyle makes an important contribution to maintaining adequate flexibility. These relationships grow stronger the older we become.

### **When should I stretch?**

Any time is a good time to Stretch. In the morning it can work out the kinks in your back, at work, you can relax your neck and shoulders, and after work stretch out your lower back. However, your should never do your stretches before you have had a chance to warm your body up.

### **How should I stretch?**

Perform the following stretches slowly and smoothly until you feel a slight "tugging" sensation on the muscles involved. Don't stretch to the point that you feel pain, don't bounce or you could pull a muscle. Hold each stretch for 10 to 20 seconds. Exhale through the stretch, and breathe slowly. This will keep you from bouncing.

### **Calf ( back of lower leg)**

1. Straight knee start with the leg to be stretched approximately three feet from the wall and the opposite leg on step forward. Lean toward the wall, keeping your heels down and feet turned in slightly.
2. Bent knee start same as above, but move approximately one foot closer to the wall and bend the knee of the back leg to be stretched.
3. Repeat using the other leg.

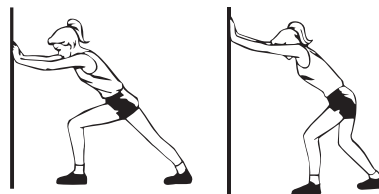

### **Iliotibial Band ( outside of hip)**

1. Start with the leg to be stretched one step back and behind the opposite foot. Move your hips sideways toward the side of your body being stretched. Keep the upper body away from the wall and do not bend forward.
2. Repeat using the other leg.

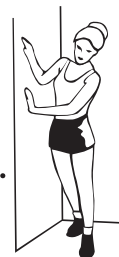

### Lower Back, Hips, Groin, and Hamstrings

1. Stand with the feet about shoulder-width apart and pointed straight ahead. If you are pretty flexible and need more of a stretch, cross one leg in front of the other for a few stretches, then switch legs.
2. Slowly bend forward from the hips, always keeping your knees slightly bent.
3. Stretch only to the point where you feel a tugging in the back of your legs.

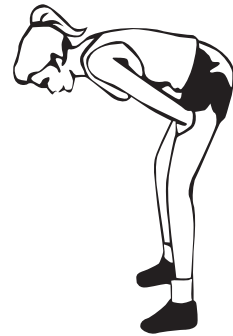

### Side Bends

1. Stand with your feet about shoulder-width apart and toes pointed straight ahead. Keep your knees slightly bent, one hand on your hip; extend your other arm up and over your head. Slowly bend at your waist to one side, toward the hand on your hip.
2. Extend both arms overhead. Hold your right hand with your left hand and bend slowly to the left, using your left arm to pull the right arm gently over the head and down toward the ground.
3. Repeat with other side.

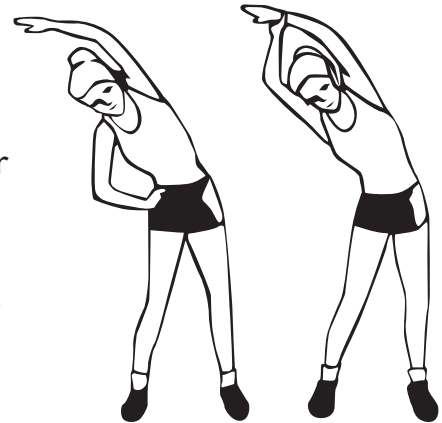

### Quadriceps (front of thigh)

1. Lying on our stomach, pull the heel toward your buttocks with the opposite hand. Keep the thigh of the leg being stretched close to the leg on the floor.
2. The same stretch can be done standing. Do not allow the thigh to come in front of you and so not bend forward at the waist.
3. Do this exercise twice – once on each leg.

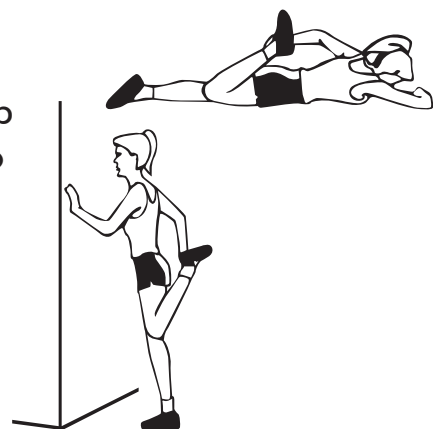

### Groin (inside of thigh)

1. Sit on the floor with the soles of your feet together. Gently push knees down toward the floor with your elbows.
2. Stand with your feet three to four feet apart and turned out slightly.
3. Keep the knee of the leg to be stretched straight, and bend the opposite knee as you move your body toward the bent leg. Keep your toes pointed forward.
4. Repeat using the other leg

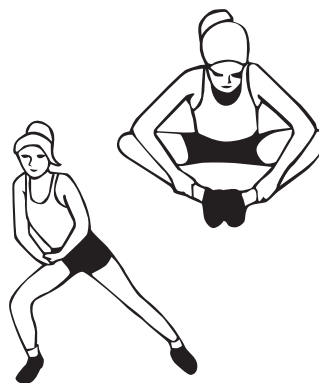

### Hamstrings (back side of upper leg)

1. Sit with one knee bent and the leg to be stretched out straight. Reach for the toes of the straight leg with the right hand and then the left hand.
2. Repeat with the other leg.



### Gluteus (back of hip)

1. Lie on your back. Pull one knee up to your chest while keeping the opposite leg down on the floor with the knee straight.
2. The same may be done standing.
3. Repeat with the other leg.

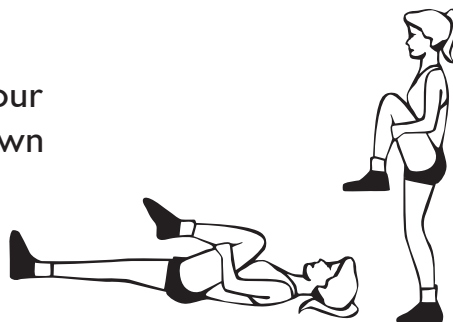

### Anterior Tibialis (front of shin)

1. Stand with all of your weight on one leg. Extend the opposite leg forward and flex and point at the ankle.
2. Repeat with the other leg.

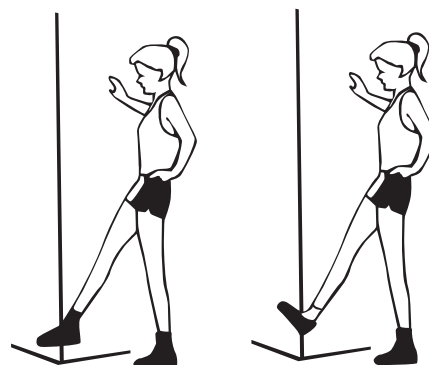

## Upright & Recumbent Bike B30/55SG/70 & R30/55SG/70

Item	Prior to Use	Weekly	Monthly	Quarterly	Bi-annual
Console		Clean			
Handlebar connection				Inspect Tighten as required	
Outer covers		Clean			
Foot Straps	Inspect				
Seat Fasteners			Inspect Tighten as required		
Seat Post					Apply light coat of lubricant
Crank arms			Inspect Tighten as required		

## Elliptical XE5/E30/E55SG/E70

Item	After Use	Weekly	Monthly	Quarterly	Bi-annual
Console	Clean				Inspect
Console Mounting Bolts					Inspect and tighten
Outer Covers		Clean			
Fasteners			Inspect and tighten		
Bearings				Inspect and Lubricate	
Footpads			Inspect and tighten		

## WARRANTY CONDITIONS

1. Ask your dealer about your warranty condition.
2. The Warranty applies only to the original owner, and covers the cost of parts repair or replacement and does not include freight charges. Proof of purchase must be demonstrated.
3. Warranty applies only to the original owner and is non transferable. If you are in US., the warranty card must be completed and sent back to FMI to complete registration. If you are out of US., please contact your dealer about your warranty situation.
4. This warranty becomes **VALID ONLY** if the Warranty Registration form included in the box is completely filled in , signed by the original purchaser and mailed to Fitnex **WITHIN 30 DAYS** of the purchaser's receipt of the products.
5. Labor coverage is provided only if an authorized Fitnex dealer or the Fitnex factory does the work.
6. Any reimbursement for travel outside of the dealers' normal service or coverage area will be the responsibility of the customer.
7. Warranty does not cover failure due to improper assembly, installation or use.
8. This warranty does not cover customer instruction, installation, set up or adjustment. User is responsible for reasonable and necessary maintenance.



## **WARRANTY CONDITIONS**

9. This warranty will not be extended to any product whose serial number has been removed, altered, or defaced.
10. This warranty does not cover damage or equipment failure caused by, or resulting from accident, misuse, abuse, improper assembly or installation, un-authorized modification, or failure to provide reasonable and necessary care as outlined in the User manual.

**FITNESS MASTER INC.**

11419 Mathis #200, Dallas, TX 75234

Tel:214-350-8884

Toll Free:1-855-846-0087

E-mail:[info@fitnonline.com](mailto:info@fitnonline.com)

<http://www.fmiamerica.com>

**JOONG CHENN INDUSTRY CO., LTD.**

3F28, No. 5, Shin-Yi Rd., Sec. 5, Taipei 110, Taiwan

Tel:886-2-2720-9980

Fax:886-2-2722-9750

E-mail:[joong@ms13.hinet.net](mailto:joong@ms13.hinet.net)

<http://www.steelflexfitness.com>