

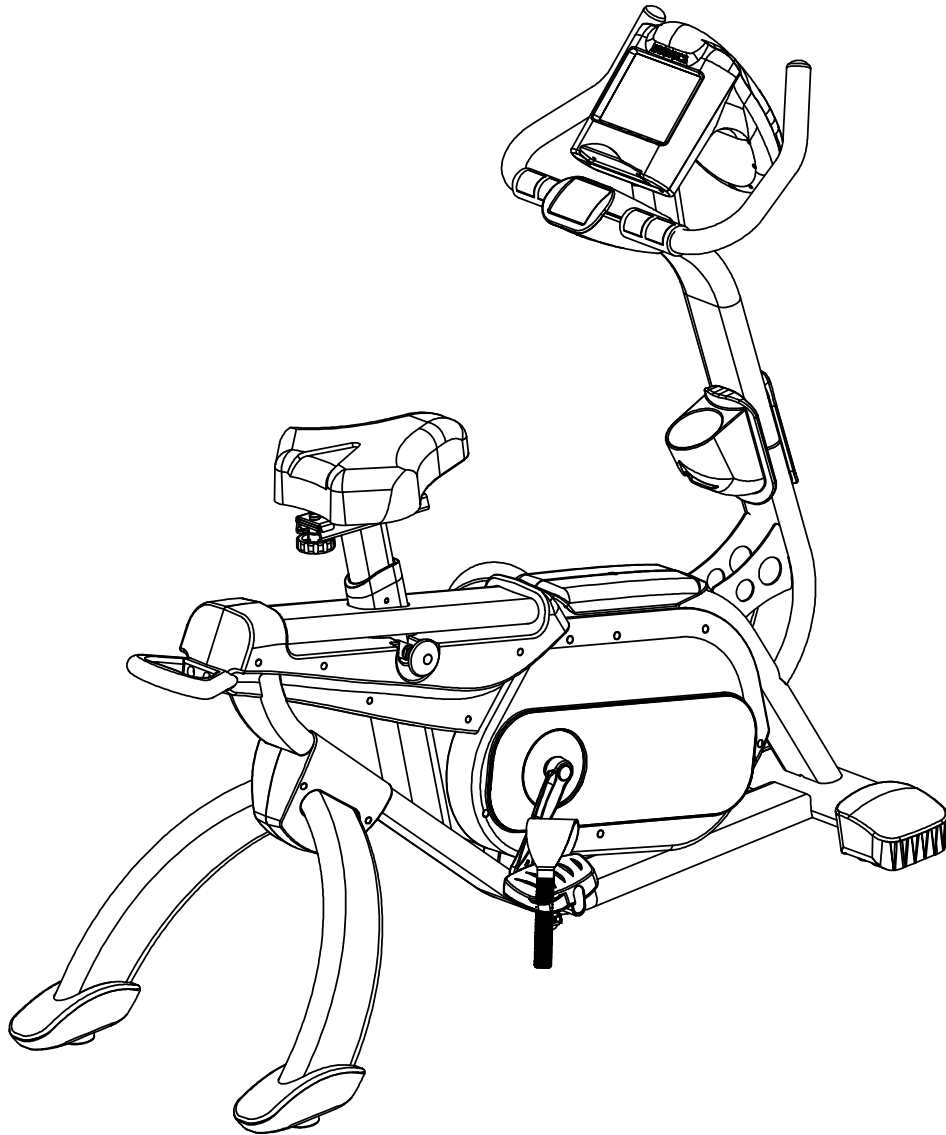

B5U



Endurance®

B5U Upright Bike

User Manual

Table of Contents

Table of Content.....	2
Introduction.....	3
Important Safety Information.....	4
Before You Begin.....	5
Assembly.....	6 - 13
Setting up B5U.....	14
Dimension.....	15
Console Overview.....	16 - 17
Console Operation.....	18 - 25
Monitoring Your Heart Rate.....	26 - 27
Chest Strap Operation.....	28
General Maintenance.....	30
Troubleshooting Guide.....	31
Stretching & Flexibility.....	32
Warm-Up/Cool Down Exercises.....	33 - 39
Parts & Hardware List.....	40 - 43
Exploded Drawings.....	44 - 46

Endurance® continually seeks ways to improve the performance, specifications and product manuals in order to ensure that only superior products are released from our factories. Please take the time to carefully read through this manual thoroughly. Instructions contained in this document are not intended to cover all details or variations possible with Endurance® equipment, or to cover every contingency that may be met in conjunction with installation, operation, maintenance or troubleshooting of the equipment. Even though we have prepared this manual with extreme care, neither the publisher nor the author can accept responsibility for any errors in, or omission from, the information given. Should additional information be required, or should situations arise that are not covered by this manual, the matter should be directed to your local Endurance® representative, or the Service Department at Endurance® in Forest Park, Illinois.

© Copyright 2012. Endurance®. All rights reserved. Endurance® reserves the right to change design and specifications when we feel it will improve the product. Endurance® machines maintain several patented and patent pending features and designs. All rights reserved on all design patents and utility patents.

Introduction

Congratulations!!

Thank you for purchasing your new Endurance® Upright Bike.

Using state-of-the-art technique, robust frame structure and superior ergonomic design, Endurance® Upright Bike set a new standard for excellence. The Endurance® Upright Bike can improve your quality of life by keeping you fit and healthy, increasing your energy levels and enhancing your lifestyle.

Endurance® wants to ensure years of quality workouts with your new Upright bike so we recommend that you read this manual carefully and thoroughly to fully understand proper use and maintenance of this product. Retain this Owner's Manual for future reference.

Please use this Owner's Manual to make sure that all parts have been included in your shipment. When ordering parts, you must use the part number and description from this Owner's Manual. Use only Endurance® replacement parts when servicing this machine. Failure to do so will void your warranty and could result in personal injury.

For information about product operation or service, check out the official Endurance® website at www.bodysolid.com/Home/Endurance-Cardio or contact an authorized Endurance® dealer or an Endurance® factory-authorized service company or contact Endurance® Customer Tech Support at one of the following:

Toll Free: 1-800-556-3113
Phone: 1-708-427-3555
Fax: 1-708-427-3556
Hours: M-F 8:30-5:00 CST
E-Mail: service@bodysolid.com

Or write to:

Endurance® Service Department
1900 S. Des Plaines Ave.
Forest Park, IL 60130 USA

URANCE®

by *Body-Solid*

Important Safety Information

Save this Owner's Manual!

Before beginning any fitness program, you should obtain a complete physical examination from your physician.

When using exercise equipment, you must always take basic precautions, including the following:

- Read all instructions before using your Endurance® Upright Bike. These instructions are written to ensure your safety and to protect the unit.
- DO NOT allow children on or near the equipment.
- Use the equipment only for its intended purpose as described in this guide.
- DO NOT use accessory attachments that are not recommended by the manufacturer. Such attachments might cause injuries and will void your warranty.
- Wear proper exercise clothing and shoes for your workout, no loose clothing.
- DO NOT use cleats, spikes or any other non-athletic shoes.
- DO NOT use this product while barefoot or wearing only socks.
- Use care when getting on or off the unit.
- DO NOT overexert yourself or work to exhaustion. If you experience any pain such as chest pains, nausea, dizziness, shortness of breath or abnormal symptoms, stop your workout immediately and consult your physician before continuing.
- Never operate the unit when it has been dropped or damaged. Return the equipment to a service center for examination and repair.
- Never drop or insert objects into any opening in the equipment.
- Always check the unit for loose components before each use.
- DO NOT turn pedals by hand.
- DO NOT use the equipment outdoors or near water. It is imperative that your Endurance® Upright bike is used in a climate controlled environment. If your Upright bike has been exposed to colder temperatures or to high moisture climates, it is strongly recommended that the Upright bike is brought to room temperature before use. Failure to use this equipment in a climate controlled environment may cause premature electronic failure.
- Endurance® recommends that a mat is placed under the unit to protect the floor or carpet and for easier cleaning.

Endurance® Upright bikes are designed for your enjoyment. By following these precautions and using common sense, you can have many safe and pleasurable hours of healthful exercise with your Endurance® Upright bike.

Before You Begin

The Endurance® B5U is carefully tested and inspected before shipment. We have shipped the unit in several pieces that require assembly. Carefully unpack the unit in a clear area and lay the pieces on the floor near the area where you plan to use the equipment. Remove the packing material. Do not dispose of the packing material until assembly is complete and the unit is working properly. Place the unit on a clean level surface for assembly. Before assembling, the unit should be placed as close as possible to its final location. *Be careful to assemble all components in the sequence presented in this guide.*

PERSONAL SAFETY DURING ASSEMBLY

- It is strongly recommended that a qualified dealer assemble the equipment. *Assistance is required.*
- Before beginning assembly, please take the time to read the instructions thoroughly.
- Read each step in the assembly instructions and follow the steps in sequence. *Do not skip ahead.* If you skip ahead, you may learn later that you have to disassemble components and that you may have damaged the equipment which will void the warranty.
- Assemble and operate the Endurance® Upright bike on a solid, level surface.
Locate the unit a few feet from the walls or furniture to provide easy access.

AFTER ASSEMBLY

Once the unit is assembled, you should check all functions to ensure correct operation. If you experience problems, first recheck the assembly instructions to locate any possible errors made during assembly. If you are unable to correct the problem, call the dealer from whom you purchased the machine or call Endurance® Customer Tech Support Hot Line Toll Free at: 1-800-556-3113.

URANCE®

by Body-Solid

Step 1

NOTE:

Some hardware components may be pre-assembled. Nylon lock nuts not fully screw onto bolts, they must be wrench tighten to fully go on.

- 1A.** Insert Rear Leg Covers (N & P) to the Rear Leg (R) .
- 1B.** Install two Rear Leg End Caps (#20) to the Rear Leg (B) using:
Four M5x10mm Pan Head Phillips Screws (#11)
- 1C.** Install the adjustable Levelers (#17) onto the Rear Leg (R)
- 1D.** Insert the Steel Plate (#14) into the U-Bracket of MAIN FRAME (A).
- 1E.** Install the Rear Leg (B) to the Steel Plate (#14) and U-Bracket of MAIN FRAME (A) using:
Two M12x25mm Hex Head Bolt (#23)
Two M12 Lock Washer (#28)
Two M12 Washer (#29)
NOTE: A second person is recommended to lift up the rear of MAIN FRAME (A) for installing the Rear Leg (R).
- 1F.** Connect Rear Leg Covers (N & P) using:
Two ST4.2x18mm Pan Head Phillips Screws (#9)

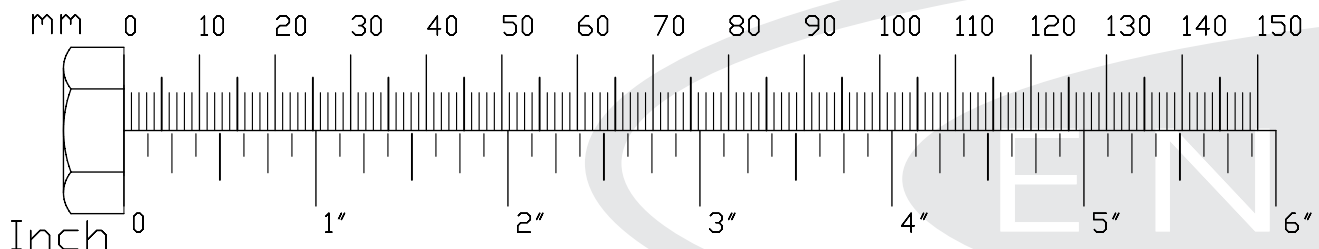

Step 1

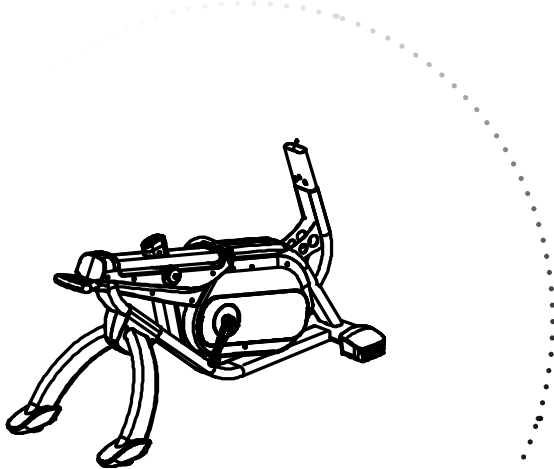

Above shows STEP 1 assembled and completed.

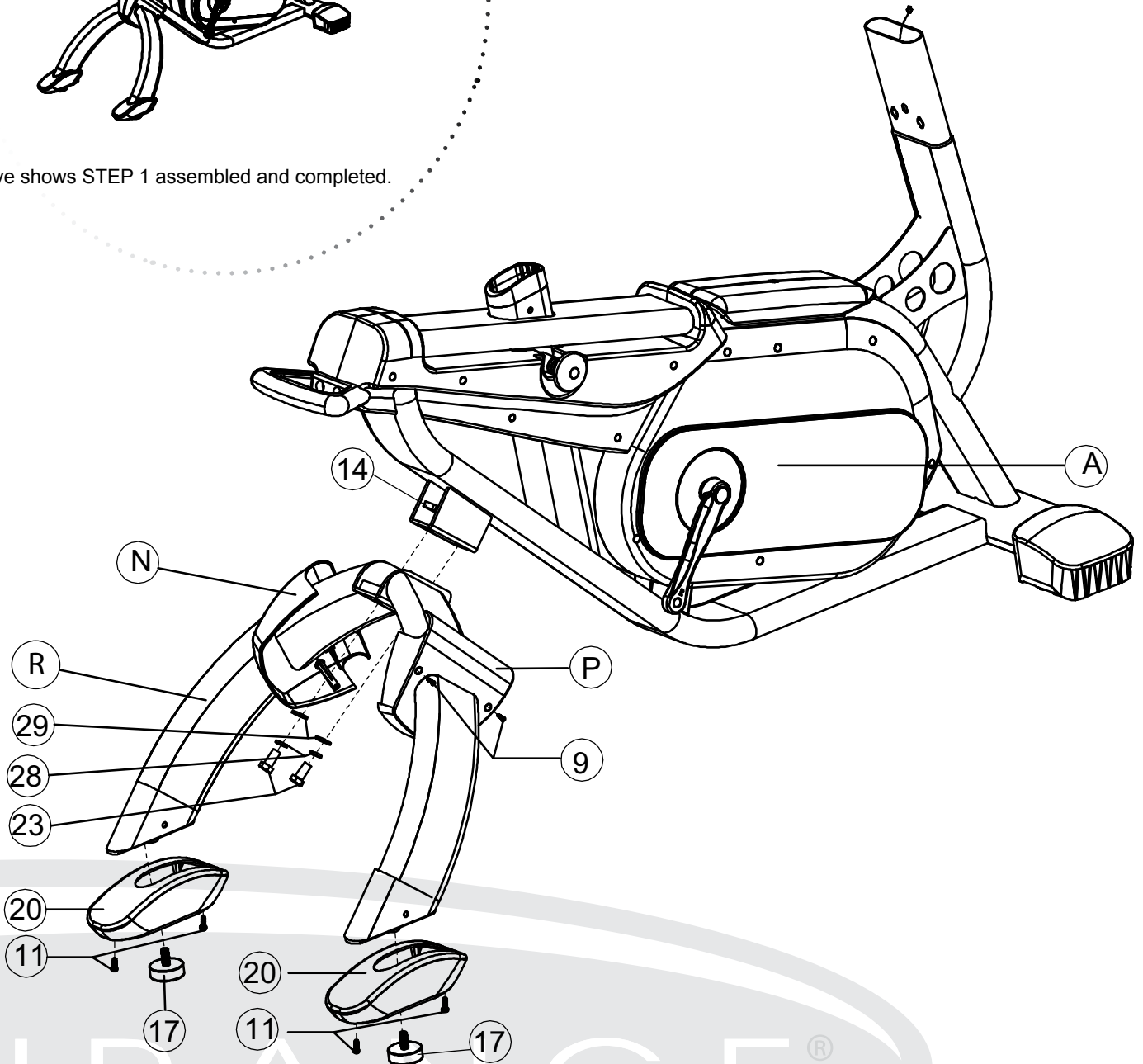

Step 2

NOTE:

Some hardware components may be pre-assembled. Nylon lock nuts not fully screw onto bolts, they must be wrench tighten to fully go on.

2A. Connect Wire Harnesses (#15 & #18) together.

2B. Attached UPRIGHT FRAME (B) to MAIN FRAME (A) using:

Two M10x50mm Socket Head Cap Screw (#10)

Two M10 Washer (#7)

Two M10 Nylon Lock Nut (#6)

2C. Attach the Front Cover (#Q) and Bottle Holder (M) to the MAIN FRAME (A) using:

Two ST4.2x18mm Pan Head Phillips Screws (#9)

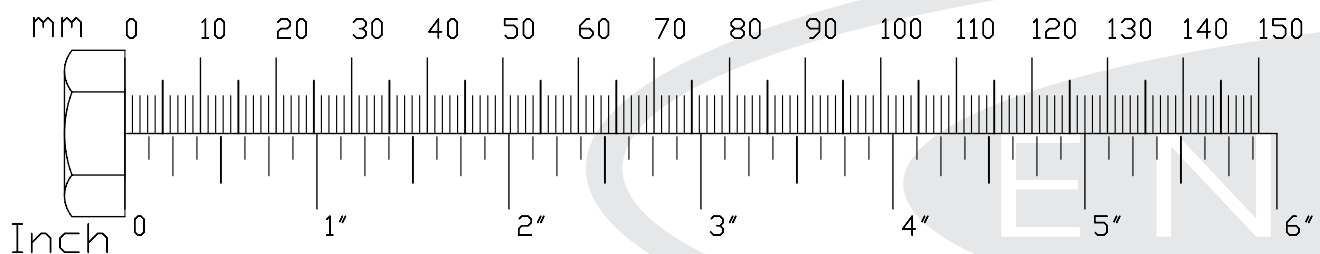

Step 2

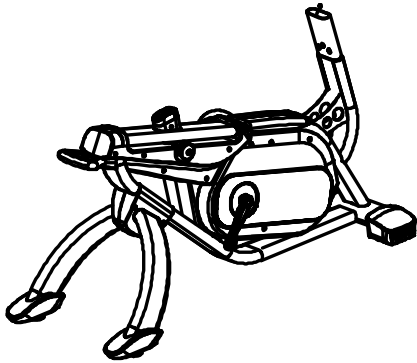

Above shows STEP 2 assembled and completed.

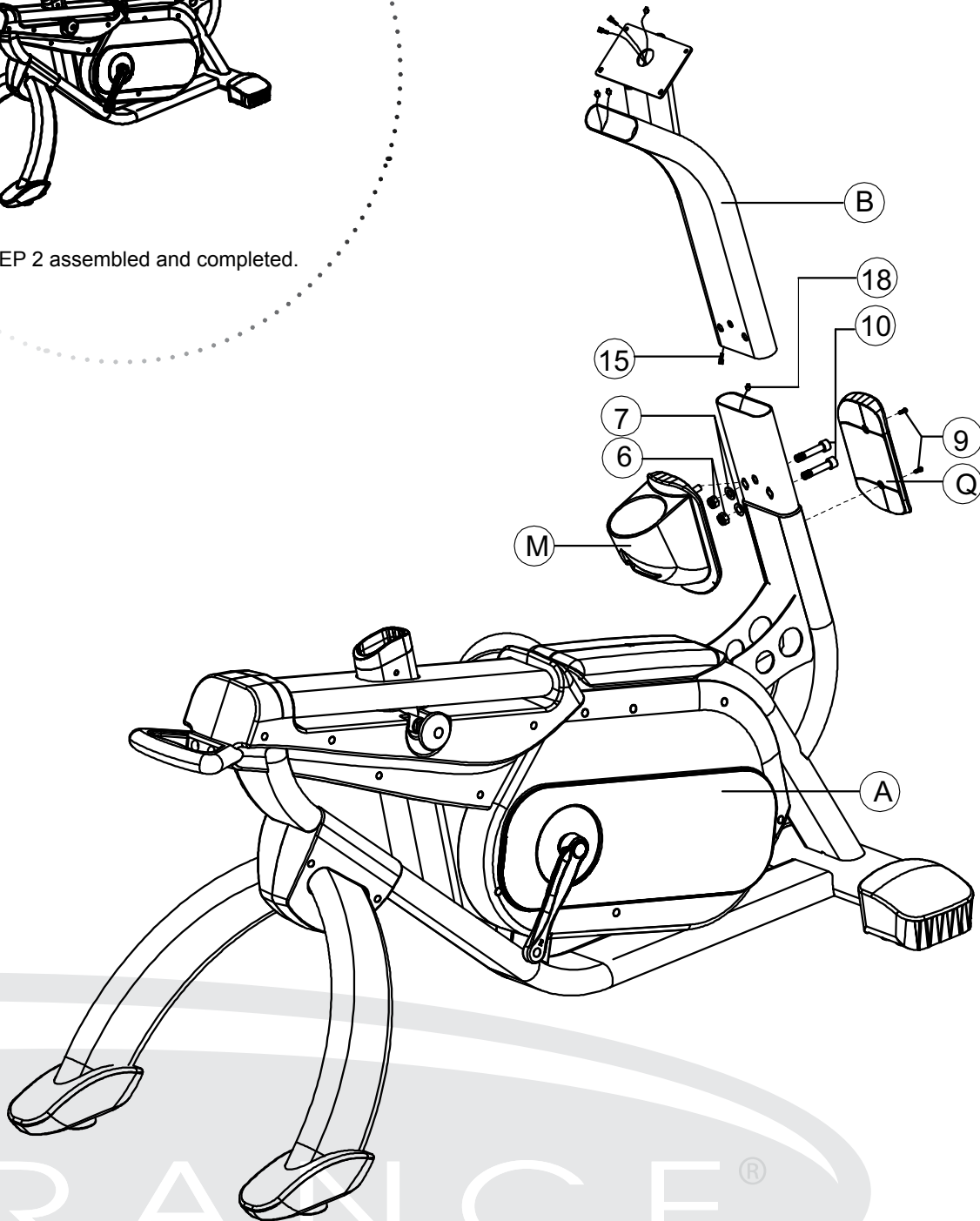

Step 3

NOTE:

Some hardware components may be pre-assembled. Nylon lock nuts not fully screw onto bolts, they must be wrench tighten to fully go on.

3A. Connect Heart Rate Cables (#12) to the Heart Rate Cables (#16).

3B. Attach Handle Bar (C) to the UPRIGHT FRAME (B) using:

Two M10x50mm Socket Head Cap Screw (#10)

Two M10 Washer (#7)

Two M10 Nylon Lock Nut (#6)

3C. Attach Handle Covers (K & L) to UPRIGHT FRAME (B) using:

Two ST4.2x18mm Pan Head Phillips Screws (#9)

3D. Attached L Shape Holder (T) to Console (H) using

two M5x10mm Phillips Head Screw (#11)

3E. Connect Heart Rate Cables (#69) to the Heart Rate Cables (#72)

3F. Connect Console Harness (#15) to the Console Harness (#71)

3G. Attach Console (H) to UPRIGHT FRAME (B) using:

Four M5x10mm Phillips Head Screw (#11)

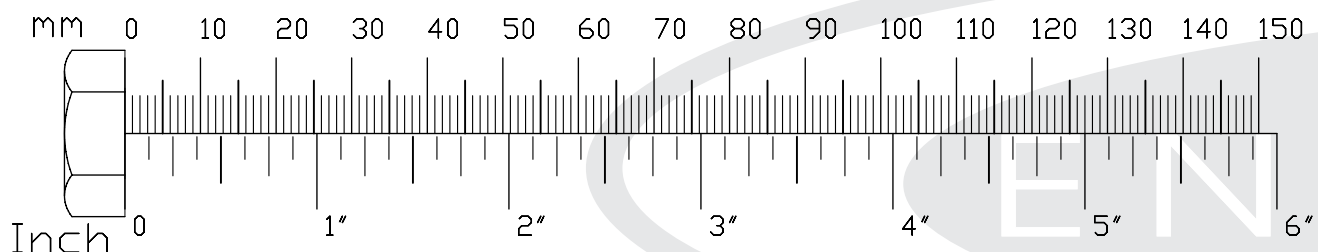

Step 3

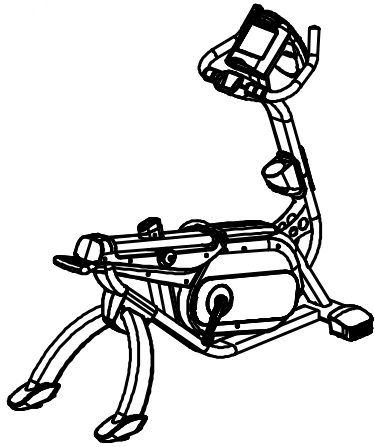

Above shows STEP 3 assembled and completed.

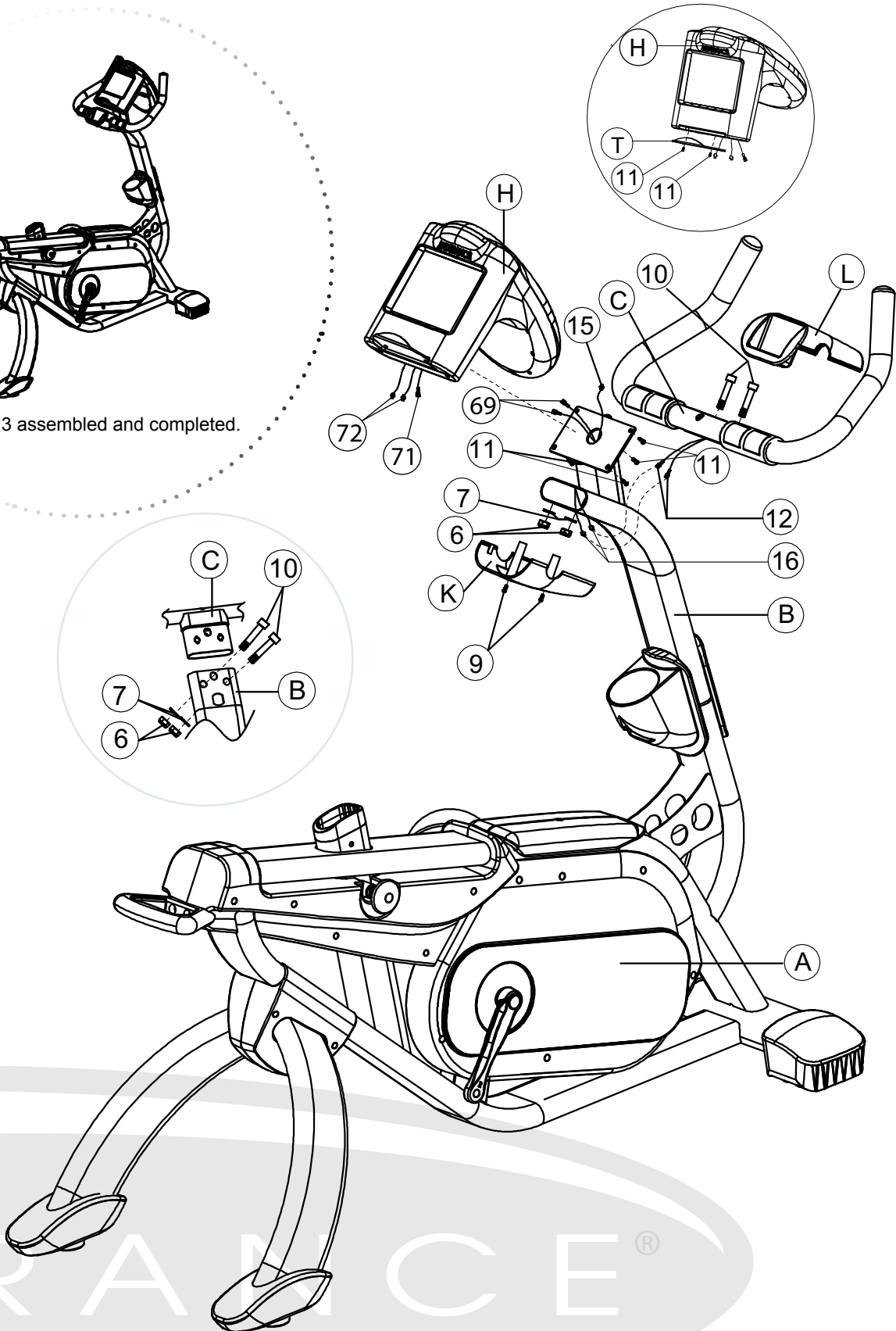

Step 4

NOTE:

Some hardware components may be pre-assembled. Nylon lock nuts not fully screw onto bolts, they must be wrench tighten to fully go on.

- 4A.** Loosen Pop Pin (#19) by turning counter-clockwise. Insert the Seat Frame (D) into MAIN FRAME (A) and align the adjustment holes of the Seat Frame (D) to the Pop Pin (#19) and tighten the Pop Pin (#19) by turning clockwise

- 4B.** Attach Seat Pad (#21) to Adjustment Bracket (E) using:
Three M8 Washer (#24)
Three M8 Nylon Lock Nut (#25)

- 4C.** Attach Adjustment Bracket (E) to Seat Frame (D) using:
One Clamping Plate (#22)
One Spacer (#26)
One Knob (#27)

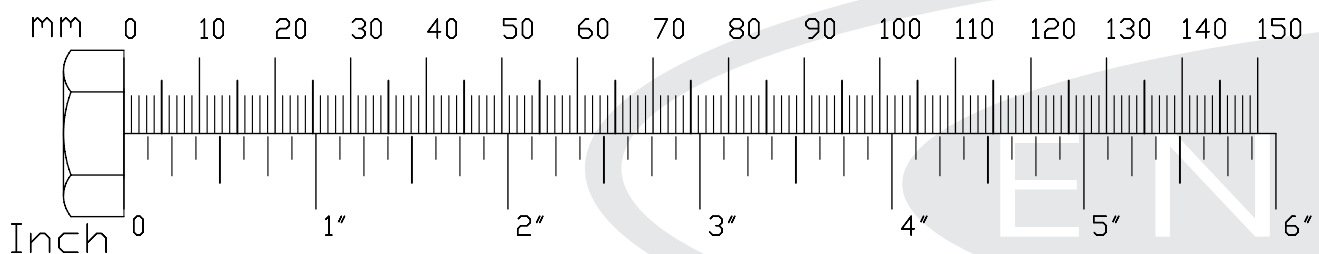

Step 4

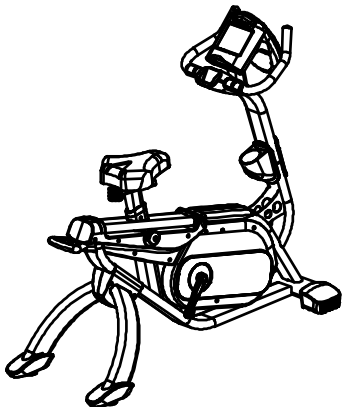

Above shows STEP 4 assembled and completed.

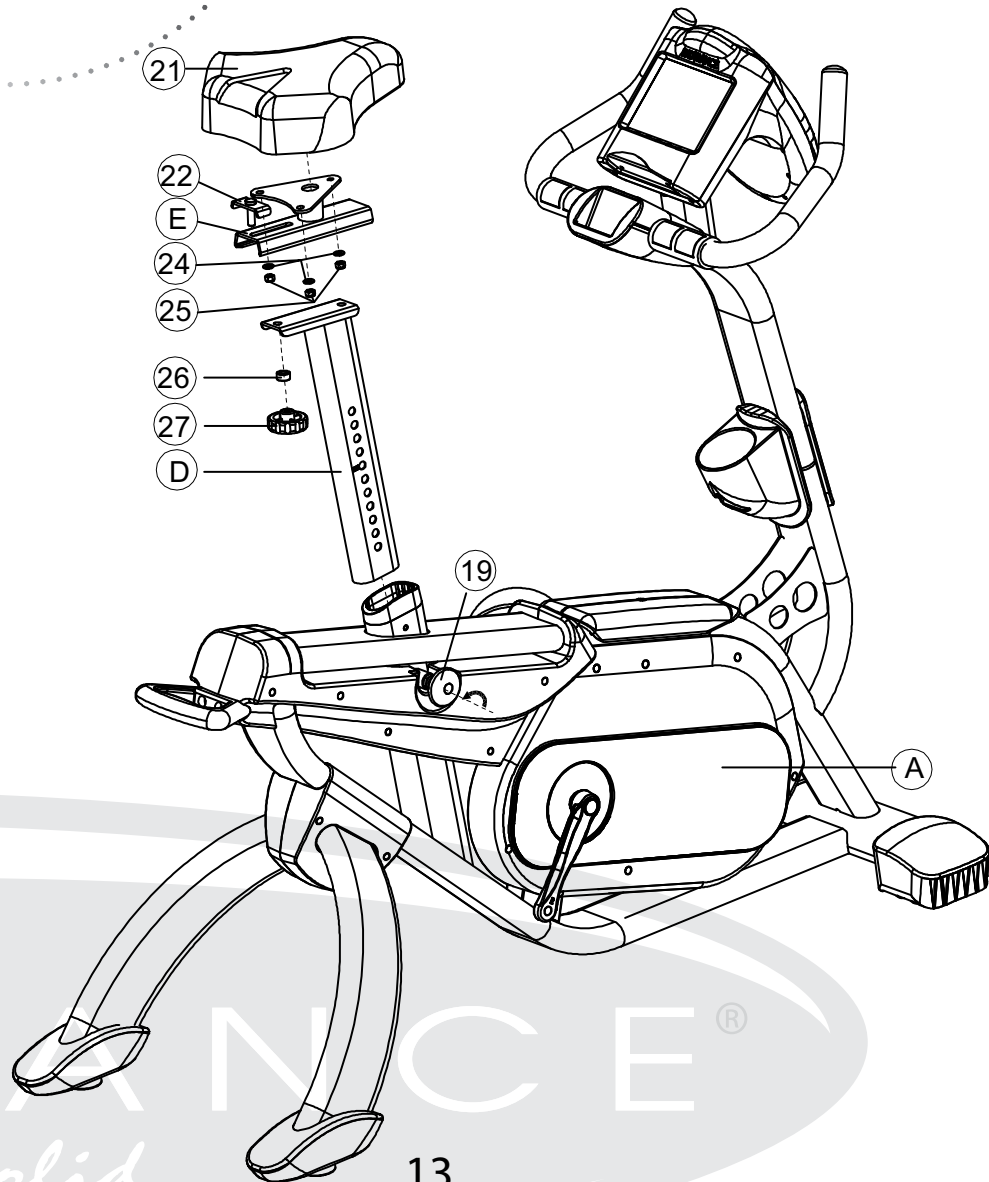

SETTING UP B5U

PLACEMENT IN YOUR HOME

To make exercise a desirable daily activity for you, the B5U should be placed in a comfortable and attractive setting. This bike is designed to use minimal floor space and to fit nicely in your gym/home.

- Do not place or operate the B5U outdoors.
- Do not place the B5U near water or in high moisture content environment.
- It is highly recommended to place a dedicated equipment mat beneath your B5U. A dedicated mat provides superior stability and firmness for a proper workout.

MOVING THE B5U

This bike is easy to move around safely.
To move the B5U:

1. Grasp the back end handle
2. Simply roll the B5U on its two wheels to the desired location.

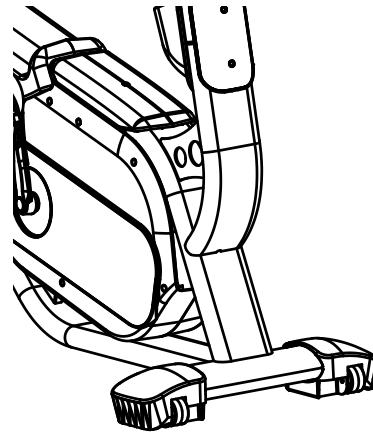
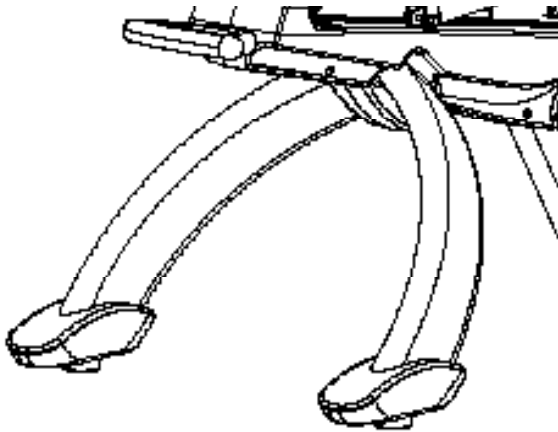

LEVELING THE B5U

The Rear Leg End Caps can be adjusted to level the B5U:

1. Rotate the Adjustable Pads on Rear Leg End Caps clockwise or counter-clockwise to adjust the level of the bike.

Dimensions

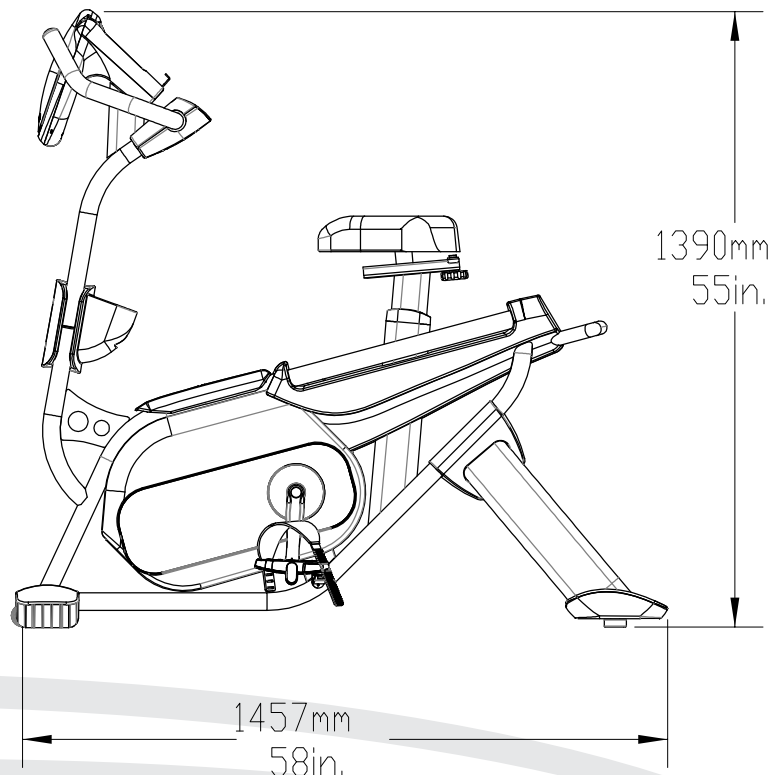
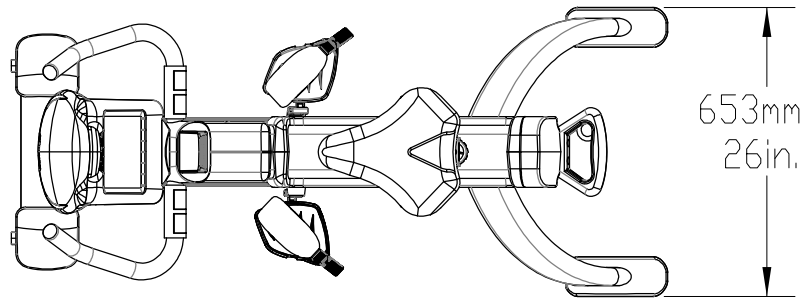

URANCE®

by *Body-Solid*

Console Screen Overview

Take a few moments to review the console Touch Screen layout.



STAR



Press the STAR  button to enter the *Quick Start Mode*.

ENTER

In *Start Program Mode*, the ENTER  button is used to go to *Workout Main Manual Mode*.

In *Workout Main Manual Mode*, the ENTER  button is used to confirm the program/values you set.





PAUSE

During *Exercise Modes*, the PAUSE  button is used to pause the program time & workout data. You can press the ENTER  button to resume the program. If the PAUSE  button is pressed twice within 2 seconds, it will end the *Exercise Mode* and go to *Workout Summary*.

Console Screen Overview

PLUS/MINUS

In *Current Setting Mode*, the PLUS  /MINUS  buttons are used to increase/decrease TIME, WEIGHT, AGE and USER LEVEL.

During *Exercise Modes*, the PLUS  /MINUS  buttons are used to increase/decrease the resistance level from 1 to 16 in the *Manual Mode* and from Level 1 to 10 in *Hill, Speed Training, Random, Fat Burn & Interval Modes*. Press and hold the PLUS  /MINUS  buttons for two seconds to rapidly increase/decrease values.

UP/DOWN

In *Workout Main Manual Mode*, the UP  /DOWN  buttons are used to toggle between workout programs.

In *Current Setting Mode*, the UP  /DOWN  buttons are used to toggle between TIME, WEIGHT AND AGE.

RETURN

In *Workout Main Manual Mode*, the RETURN  button is used to go back to the previous program

In *Current Setting Mode*, the RETURN  button is used to go back to *Workout Main Manual Mode*.

During *Exercise Modes*, the RETURN  button is used to go back to *Start Program Mode*.

In *Woutout Summary Mode*, the RETURN  button is used to go back to *Start Program Mode*.

COOL DOWN

During *Exercise Modes*, the COOL DOWN  button is used to go back to *Cool Down Mode*. The Cool Down Time is set to 5 minutes.

CRUISE

During *Exercise Modes*, the CRUISE  button is used to go to *Cruise Control Mode*. It keeps the resistance level constant at the moment you enter *Cruise Control Mode*.

URANCE®

Console Operation





Below are the main screens on the console:

START PROGRAM

The screen displays QUICK STAR  and ENTER  buttons









WORKOUT MAIN MANUAL

The screen displays Program Names, RETURN , ENTER , and the UP  /DOWN  buttons.



Console Operation

CURRENT SETTING (REGULAR PROGRAMS)

The screen displays TIME, AGE, WEIGHT, RESISTANCE, RETURN , ENTER , UP  /DOWN  and PLUS  /MINUS  buttons.

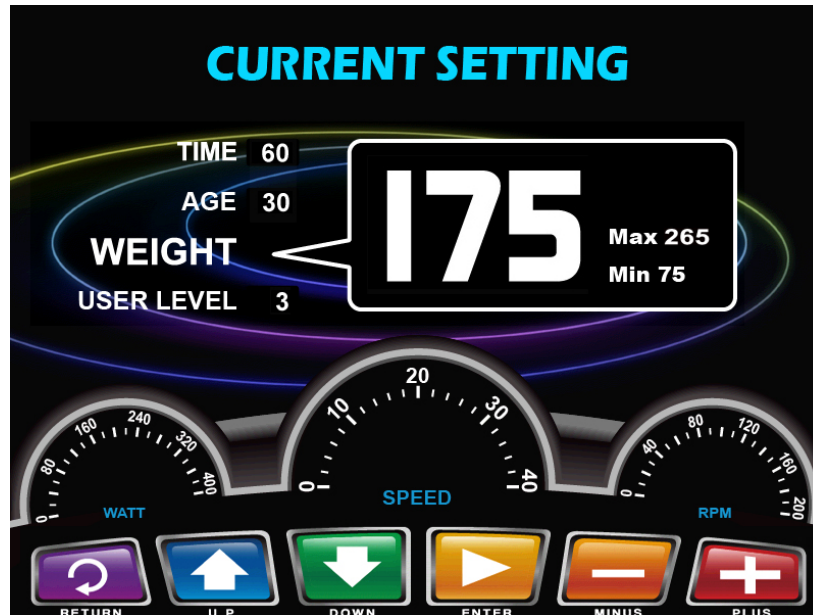







EXERCISE MODE

The screen displays TIME, DISTANCE LEVEL, CALORIES, HEART RATE, WATT, SPEED, RPM, RETURN , ENTER , COOL DOWN , CRUISE , PAUSE , and PLUS  /MINUS  buttons.



Console Operation

COOL DOWN

The screen displays TIME, DISTANCE LEVEL, CALORIES, HEART RATE, WATT, SPEED, RPM, RETURN , ENTER , COOL DOWN , PAUSE , and PLUS  /MINUS  buttons.

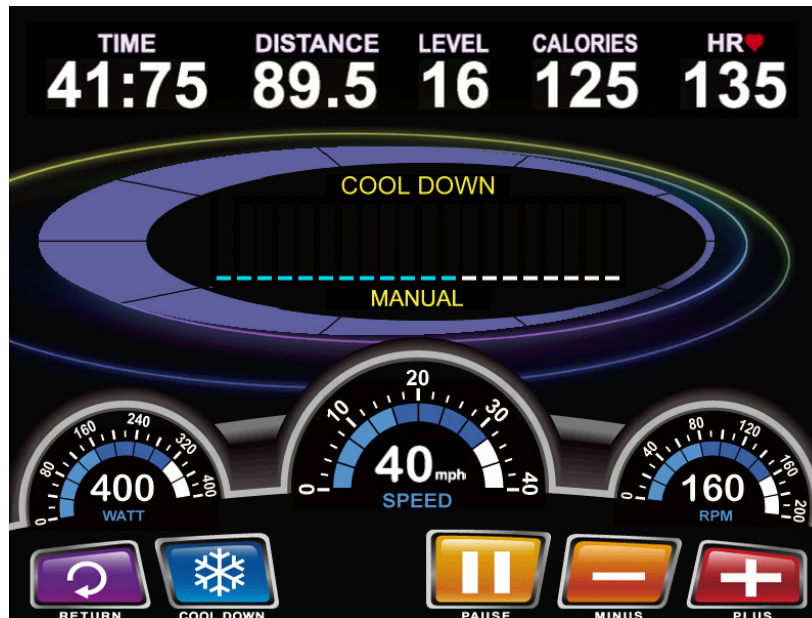

CRUISE

The screen displays TIME, DISTANCE LEVEL, CALORIES, HEART RATE, WATT, SPEED, RPM, RETURN , ENTER , COOL DOWN , CRUISE , PAUSE  buttons.



Console Operation

CURRENT SETTING (TARGET HEART RATE PROGRAMS)

The screen displays TIME, AGE, WEIGHT, TARGET HEART RATE, RETURN , ENTER , UP , DOWN  and PLUS  /MINUS  buttons.

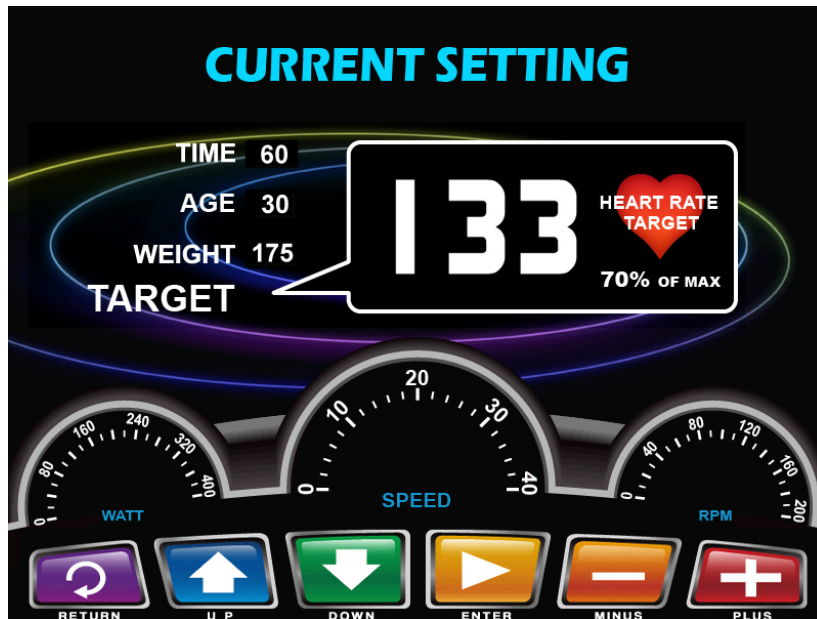

WORKOUT SUMMARY

The screen displays WORKOUT TIME, DISTANCE, CALORIES, AVERAGE RESISTANCE, AVERAGE WATT, AVERAGE SPEED, AVERAGE RPM, and RETURN  button. After 30 seconds, it will go back to START PROGRAM screen.

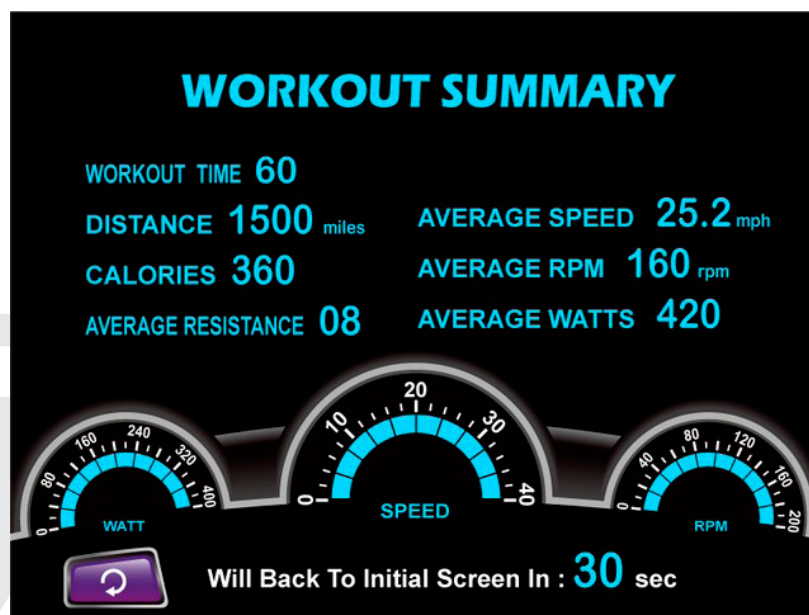



UR

by Body-Solid

Console Operation

QUICK START MODE

The Quick Start Program allows the user to quickly start using the machine without the use of preset programs. To enter *Quick Start (Manual) Mode*, Press the STAR  button on the START PROGRAM screen. Time is pre-set at 20 minutes. Weight is pre-set at 150 lb. The RESISTANCE LEVEL can be changed at any time by pressing the PLUS  /MINUS  buttons.

REGULAR PROGRAM MODE

There are six preset regular preset programs. They are MANUAL, HILL, SPEED TRAINING, RANDOM, FATBURN, INTERVAL.

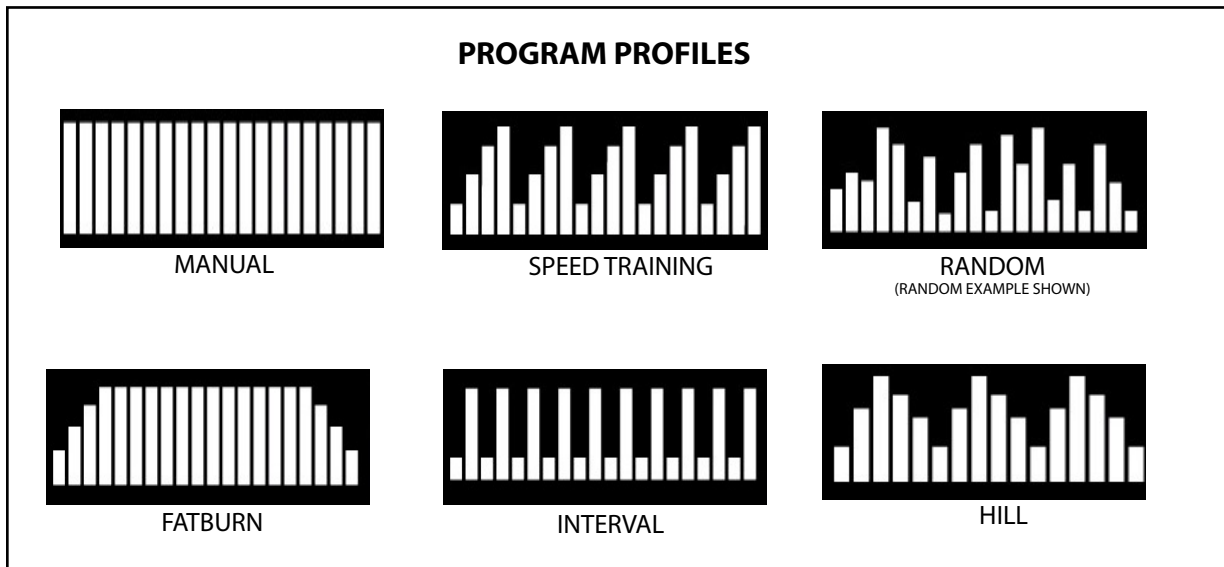

MANUAL

This program allows the user to have the complete control over their workout. The user can make adjustment on resistance level from 1 to 16.

HILL

This program takes the user through two hill profiles. Resistance changes are small during this program. This is a good program to get started with or for someone looking for a lower stress workout.

SPEED TRAINING

This program simulates interval training with more extreme levels of high and low intensity levels.

Console Operation

RANDOM

This program randomly generates a new program profile every time it is chosen. This allows you to keep the workouts fresh and motivating. The RANDOM program will be different every time you use it.



INTERVAL





This program varies the intensity of the workout between low and high resistance to quickly raise and lower the heart rate thru a series of high & low profiles.









FATBURN

This program gets your heart rate fast and maintains it at 65% of your calculated maximum heart rate with slight variation to provide optimal calories burn.

To enter **Regular Program Mode:**

In the *Workout Main Manual Mode*, the user can toggle between each program by using the UP /DOWN  buttons, press ENTER  to choose the program and go to *Current Setting Mode*.

In the *Current Setting Mode*, the user can enter TIME(05-99mins), AGE (10-99), WEIGHT (75-265lb), RESISTANCE (LEVEL 1-16 for MANUAL, LEVEL 1-10 for other five programs) adjustments using the UP /DOWN  and PLUS /MINUS  buttons. After the user finish the setting, press the ENTER  button to go to *Exercise Mode*.

During *Exercise Mode*, the user can change RESISTANCE LEVEL using PLUS /MINUS  buttons. The RETURN  button is used to go back to *Start Program Mode*. The COOL DOWN  button is used to go back to *Cool Down Mode*. The Cool Down time is 5 minutes. The CRUISE CONTROL  button is used to go to *Cruise Control Mode*. The PAUSE  button is used to pause the program time & workout data. Workout data would be retained for 5 minutes before the screen shuts down automatically. When the user press the PAUSE  button twice within 2 seconds, it will end the *Exercise Mode* and go to *Workout Summary*. The ENTER  button is used to resume the program time & workout data.

URANCE®

by Body-Solid

Console Operation

HEART RATE PROGRAMS (See the MONITORING YOUR HEART RATE section for more information)

Heart rate control programs are designed to automatically change resistance to keep your heart rate at a predetermined level based on the selected Heart Rate program. Each Heart Rate program is designed with a specific goal in mind.

The preset Heart Rate Programs are TARGET HEART RATE, HR FATBURN, HR CARDIO, HR HILL, HR INTERVAL

% (TARGET HEART RATE)

% Target Heart Rate allows the user to select a Target Heart Rate (See section titled MONITORING YOUR HEART RATE for more information) that would like to be maintained during the exercise session.

HR 80% (CARDIO)

HR 80% maintains the Target Heart Rate at 80% of the Maximum Heart Rate by automatically adjusting resistance levels. This program provides for a high intensity, cardiovascular workout.

HR 65% (FAT BURN)

HR 65% maintains the Target Heart Rate at 65% of the Maximum Heart Rate by automatically adjusting the resistance levels. This program provides the ultimate fat burning workout.

HR 60-85% (HILL)

HR Hill simulates hill training by alternates between 60% and 85% of your Max HR.

HR 60-85% (INTERVAL)

The HR INTERVAL program alternates between 60% and 85% of your Max HR. This program provides an excellent fat burn and cardiovascular workout.



END

Console Operation

HOW HEART RATE PROGRAMS WORK

Change in Heart Rate (Δ HR) = Beats per minute difference between
Target Heart Rate (THR) and Current Heart Rate (CHR).

or: Δ HR = THR (bpm) - CHR (bpm)

The Heart Rate Programs will behave in the following manner:

Δ HR is between +/-5

Resistance level stays the same.

Δ HR greater than 5



Resistance level increases. The console's computer will check the user's Heart Rate every 10 seconds and adjust the resistance level to fit the Target Heart Rate.





Δ HR less than -5







Resistance level decreases. The console's computer will check the user's Heart Rate every 10 seconds and adjust the resistance level to fit the Target Heart Rate.

HEART RATE PROGRAM MODE

To enter *Heart Rate Program Mode*:

In the *Workout Main Manual Mode*, the user can toggle between each program by using the UP /DOWN  buttons, press ENTER  to choose the program and go to *Current Setting Mode*.

In the *Current Setting Mode*, the user can enter TIME(05-99mins), AGE (10-99), WEIGHT (75-265lb), TARGET (desired target heart rate) using the UP /DOWN  and PLUS /MINUS  buttons. After the user finish the setting, press the ENTER  button to go to *Exercise Mode*.

During *Exercise Mode*, the RETURN  button is used to go back to *Start Program Mode*. The COOL DOWN  button is used to go back to *Cool Down Mode*. The CRUISE CONTROL  button is used to go to *Cruise Control Mode*. The PAUSE  button is used to pause the program time & workout data. Workout data would be retained for 5 minutes before the screen shuts down automatically. When the user press the PAUSE  button twice within 2 seconds, it will end the *Exercise Mode* and go to *Workout Summary*. The ENTER  button is used to resume the program time & workout data.

Monitoring Your Heart Rate

To obtain the greatest cardiovascular benefits from your exercise workout, it is important to work within your target heart rate zone. The American Heart Association (AHA) defines this target as 60% -75% percent of the Maximum Heart Rate.

The Maximum Heart Rate may be roughly calculated by subtracting the user's age from 220.

The Maximum Heart Rate and aerobic capacity naturally decreases as the user ages. This may vary from one person to another, but use this number to find your approximate effective target zone. For example, the Maximum Heart Rate for an average 40 year-old is 180 bpm. The target heart rate zone is 60%-75% of 180 or 108-135 bpm. See the **FITNESS SAFETY** section.

Before beginning a workout, check the normal resting heart rate. The user can place their fingers lightly against the neck or wrist over the main artery. After finding the pulse, count the number of beats in 10 seconds. Multiply the number of beats by six to determine your pulse rate per minute. It is recommend to take a heart rate measurement at rest, after warming up, during the workout and two minutes into cooling down after the workout, to accurately track progress as it relates to better fitness.

During your first several months of exercising, the AHA recommends aiming for the lower part of the target heart rate zone - 60%, then gradually progressing up to 75%. According to the AHA, exercising above 75% of the Maximum Heart Rate may be too strenuous unless the user is in top physical condition. Exercising below 60% of the maximum will result in minimal cardiovascular conditioning.

CHECK YOUR PULSE RECOVERY RATE

If your pulse is over 100 bpm five minutes after stopping exercising, or if it's higher than normal the morning after exercising, the user's exertion may have been too strenuous for their current fitness level. Rest and reduce the intensity next time.

Monitoring Your Heart Rate

FITNESS SAFETY

The Heart Rate chart indicates average rate zones for different ages. A variety of different factors (including medication, emotional state, temperature and other conditions) can affect the target heart rate zone that is best for you. Your physician or health care professional can help you determine the exercise intensity that is appropriate for your age and condition.

(MHR) = Maximum Heart Rate

(THR) = Target Heart Rate

$220 - \text{Age} = \text{Maximum Heart Rate (MHZ)}$

$\text{MHZ} \times .60 = 60\% \text{ of your Maximum Heart Rate.}$

$\text{MHZ} \times .75 = 75\% \text{ of your Maximum Heart Rate.}$

For example, if you are 30 years old, your calculations will be as follows:

$220 - 30 = 190$

$190 \times .60 = 114$ (Low End or 60% of MHZ)

$190 \times .75 = 142$ (High End or 75% of MHZ)

30 Year-Old (THR) Target Heart Rate would be 114-142

MaximumHeartRate(MHR)Calculation

HEART RATE TRAINING ZONE						
MAX	BEATS PER MINUTE					
85%	170	161	153	144	136	128
70%	140	133	126	119	112	105
60%	120	114	108	102	96	90
AGE	20	30	40	50	60	70

Heart Rate Training Zone Chart

URANCE®

by Body-Solid

Chest Strap Operation

Your Endurance® Upright bike has the capability to determine Heart Rate with the use of a Heart Rate Chest Strap. A Heart Rate Chest Strap has been provided with your unit or may be available as an accessory for use with your unit depending on the Endurance® model purchased. In all Heart Rate Control programs, the console only accepts the heart rate signal from the chest strap transmitter while the pulse grip heart rate function is disabled. The requirement to wear the chest strap is due to the superior accuracy of a chest strap transmitter compared to the pulse grip sensors.

It is suggested for the Chest Strap Transmitter that you position the transmitter as close to your heart as possible, against the skin, 1-2 inches below the pectoral muscles. For best results, moisten the back of the transmitter for better contact.

If no Heart Rate signal is detected for 10 seconds, the screen will show "0" Heart Rate

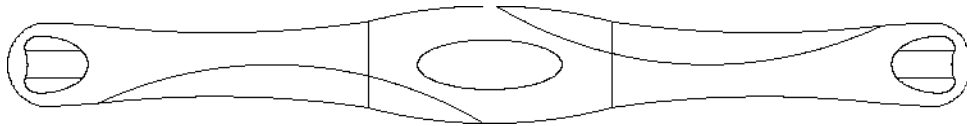

HR Chest Strap for Endurance® models B5U & B5U

SAFETY PRECAUTIONS AND TIPS FOR CHEST STRAP

1. It is the owner's responsibility to ensure that all users of this unit have read the Owner's Manual and are familiar with warnings and safety precautions.
2. Do not place chest strap near devices that generate large magnetic fields. TV sets, electric motors, radios, and high voltage power lines can affect the transmitter's performance. These items can interfere with the heart rate signal and possibly affect the heart rate readings on the console.
3. Handle the Chest Strap with care. Dropping the transmitter might cause damage that could void the warranty.
4. Do not use the chest strap if you have a cardiac pacemaker or if you are taking medications for a heart condition. Medication or electrical pulses from the pacemaker can interfere with accurate heart rate readings.
5. Do not bend the strips inside the chest strap. This can cause the chest strap to lose conductivity.
6. The chest strap has batteries that need to be replaced periodically. A faulty battery can cause inaccurate reading.

END

URANCE®

by *Body-Solid*

General Maintenance

Your Endurance® B5 Exercise Bike has been manufactured to withstand many hours of use with minimal maintenance. Here are some maintenance tips to keep your Endurance® B5 Exercise Bike running at its best.

CLEANING

Periodically wipe down your machine with mild, soapy water or a diluted general purpose non-abrasive household cleaner. Cleaner should never be applied directly to any part of the equipment. Instead, place the non-abrasive cleaning solution on a soft cloth and wipe down the unit. The Exercise Bike should be wiped down to remove sweat after each use.

SQUEAKING NOISE

If squeaking noise occurs, the main is mostly likely one of the three reasons:

1. The hardware is not sufficiently tightened during assembly. Please check and tighten all bolts.
2. Dirt build-up on the rails and wheels. Clean the rails and wheels with a lint free cloth and rubbing alcohol. After cleaning, apply a small amount of lubricant on Rail with your fingers or a lint free cloth.
3. The unit is not properly leveled. There are two leveling pads on the rear legs to adjust the level of the bike.

Troubleshooting Guide

Symptom	Possible Cause	Solution
Console has no power.	Console cable is not connected?	Verify that the console cable is connected properly.
	The console is faulty?	Call the Endurance® service number.
Strides/Min or Speed shows 0	Computer isn't receiving a signal from the sensor?	Check that the sensor magnet is correctly fitted and passes in front of the sensor.
		Check that all the computer plugs and sockets are correctly and firmly connected.
	The sensor is faulty?	If all above checks are O.K., then replace sensor.
	The computer is faulty?	Call the Endurance® service number.
No HR signal or incorrect HR signal	Computer is receiving a faint or intermittent pulse signal.	Check to make sure that the batteries in the chest strap are installed correctly.
		Replace the chest strap batteries.
		Check to see if the receiver is properly installed.
		Check to see if the chest strap is being properly worn by the user - if skin is extremely dry, then moisten contact points on chest with water and try again.
		If the problem still exists then call the Endurance® service number.
Noise from Bike	Loose hardware or dirt build up.	Check and tighten hardware
	Dirt build up.	Clean up the dirt
	The Problem still exists.	Call the Endurance® service number.

Any Questions?
 Call the Customer Tech Hotline at:
 1 (800) 556-3113

URANCE®

by Body-Solid

Stretching & Flexibility

Flexibility is an important component of physical fitness and needs to be addressed in a resistance training program. The two main purposes for stretching are injury prevention and a faster rate of recovery from exercise. Stretching should be performed in both the warm up and cool down phases of a training session. A good general guideline is that each workout session should be preceded by 5 to 15 minutes of general warm up, followed by 8 to 12 minutes of stretching, and concluded with 4 to 5 minutes of post-exercise stretching.

A regular stretching program will loosen muscle tissue, allowing an increased range of motion. This helps prevent micro-tears at the muscle-tendon junction. Almost 90% of all injuries from muscle strain occur at the muscle-tendon junction. Repeated injury at this junction can lead to a build-up of scar tissue, which impedes range of motion and adds stress to the joints.

Begin by stretching the major muscle groups first. Move in and out of your stretches with smooth, slow, controlled motion. Hold the stretch for at least 10 seconds when you feel you have reached your muscle's maximum distance. Do not use fast, hurried or reckless motions when stretching. Fast and bouncy motions will increase the risk of injury.

The most common and most popular type of stretching is the static stretching technique. This form of stretching involves voluntary, complete relaxation of the muscles while they are elongated. A static stretch is a constant, steady stretch in which the end position is held for 10 to 30 seconds. This technique is popular because it is easy to learn, effective, and accompanied by minimal soreness with the least risk of injury.

Ballistic stretching involves a bouncing or bobbing movement during the stretch. The final position in the movement is not held. Ballistic stretching is unpopular because of the increased amount of delayed muscle soreness and the possibility of injury during the stretching exercise. Ballistic stretching is not recommended.

A dynamic stretch involves flexibility during sport specific movements. Dynamic stretching is similar to ballistic stretching in that it utilizes movement, but dynamic stretching includes movements that may be specific to a sport or movement pattern. Dynamic stretching is most common among track and field athletes, but is also used in other sports, such as basketball and volleyball. An example of dynamic stretching would be a track sprinter performing high knees with an emphasis on knee height and arm action, not on horizontal speed.

The following pages show illustrations with descriptions of static stretching for warm up and post-exercise cool down. Remember... stretch your large muscle groups first and do all stretches in a smooth, slow, controlled manner.



END

Warm Up/Cool Down Exercises

UPPER BACK

Cross Arm in Front of Chest

MUSCLE(S) AFFECTED: *latissimus dorsi and teres major*

1. Stand or sit with the right arm slightly flexed (15° to 30°) and adducted across the chest.
2. Grasp the upper arm just above the elbow, placing the left hand on the posterior side of the upper arm.
3. Pull the right arm across the chest (toward the left) with the left hand; hold for 10 seconds.
4. Repeat with the left arm.



Stretching the upper back



Stretching the shoulders, chest and upper back

UPPER BACK

Arms Straight Up Above Head (Pillar)

MUSCLE(S) AFFECTED: *latissimus dorsi and wrist flexors*

1. Stand with arms in front of torso, fingers interlocked with palms facing each other.
2. Slowly straighten the arms above the head with palms up.
3. Continue to reach upward with hands and arms.
4. While continuing to reach upward, slowly reach slightly backward; hold for 10 seconds.

LOWER BACK

Spinal Twist (Pretzel)

MUSCLE(S) AFFECTED: *internal oblique, external oblique and spinal erectors*

1. Sitting with legs straight and upper body nearly vertical, place right foot on left side of left knee.
2. Place back of left elbow on right side of right knee, which is now bent.
3. Place right palm on floor 12 to 16 inches behind hips.
4. Push right knee to the left with left elbow while turning shoulders and head to the right as far as possible. Try to look behind the back. Hold for 10 seconds.
5. Repeat with left leg.



Stretching the lower back and sides

URANCE®

by Body-Solid

Warm Up/Cool Down Exercises

LOWER BACK

Semi-Leg Straddle

MUSCLE(S) AFFECTED: *spinal erectors*

1. Sitting, knees flexed 30 to 50 degrees, let the legs totally relax.
2. Point the knees outward; the lateral side of the knees may or may not touch the floor.
3. Lean forward from waist and reach forward with extended arms; hold position for 10 to 15 seconds.
4. Bending and relaxing legs decreases hamstring involvement and increases lower back stretch.



Stretching the lower back from a seated position



Rotational flexion of the neck

NECK

Look Right and Left

MUSCLE(S) AFFECTED: *sternocleidomastoid*

1. Stand or sit with head and neck upright.
2. Turn head to the right using a sub-maximal concentric contraction; hold for 10 seconds.
3. Turn head to the left using a sub-maximal concentric contraction; hold for 10 seconds.

NECK

Flexion and Extension

MUSCLE(S) AFFECTED: *sternocleidomastoid, suboccipitals and splenii*

1. Standing or sitting with head and neck upright, flex neck anteriorly (forward) by tucking chin in toward the chest; hold for 10 seconds.
2. If the chin touches the chest, try to touch lower on the chest with the chin.
3. Extend neck posteriorly (backward) by trying to touch the head to the trapezius; hold for 10 seconds.



Neck Extension

Neck Flexion

Warm Up/Cool Down Exercises

CHEST/SHOULDER

Straight Arms Behind Back

MUSCLE(S) AFFECTED: *deltoids and pectoralis major*

1. Standing, place both arms behind back.
2. Interlock fingers with palms facing each other.
3. Straighten arms fully.
4. Slowly raise the straight arms; hold for 10 to 15 seconds.
5. Keep head upright and neck relaxed.



Stretching the sides, upper back and shoulders



Stretching shoulder joints and chest while standing

SIDES

Side Bend with Straight Arms

MUSCLE(S) AFFECTED: *external oblique, latissimus dorsi and serratus anterior*

1. Stand with feet 14 to 16 inches apart.
2. Interlace the fingers with palms facing each other.
3. Reach upward with straight arms.
4. Keeping arms straight, lean from waist to left side. Do not bend knees.
5. After moving as far as possible; hold for 10 seconds.
6. Repeat to the left side.

SIDES

Side Bend with Bent Arms

MUSCLE(S) AFFECTED: *external oblique, latissimus dorsi, serratus anterior and triceps*

1. Stand with feet 14 to 16 inches apart.
2. Flex right arm and raise elbow above head.
3. Reach the right hand down toward the left shoulder.
4. Grasp the right elbow (just above the elbow) with the left hand.
5. Pull the elbow behind head.
6. Keeping arm bent, lean from waist to left side.
7. Do not bend knees.
8. After moving as far as possible; hold for 10 to 15 seconds.
9. Repeat with the left arm.



Stretching the sides, triceps and upper back

URANCE®

by Body-Solid

Warm Up/Cool Down Exercises

ANTERIOR OF THIGH AND HIP FLEXOR

Side Quadricep Stretch

MUSCLE(S) AFFECTED: *quadriceps and iliopsoas*

1. Lie on left side with both legs straight.
2. Place left forearm flat on floor and upper arm perpendicular to floor.
3. Place left forearm at 45° angle with torso.
4. Flex right leg with heel of right foot moving toward buttocks.
5. Grasp front of ankle with right hand and pull toward buttocks.
WARNING: Do not pull on ankle so hard that pain or discomfort is felt in knee.
6. Move knee backward and slightly upward. The stretch occurs not so much from the excessive flexion of the knee but from moving the knee back and slightly up; hold for 10 to 15 seconds.
7. Repeat with the left leg.



Stretching the quadriceps on side



Stretching the quadriceps kneeling

ANTERIOR OF THIGH AND HIP FLEXOR

Kneeling Quadriceps Stretch

MUSCLE(S) AFFECTED: *quadriceps*

1. Kneel with the balls of the feet on the ground.
2. Keep hips straight (upper leg and torso should be in a straight line).
3. Place palms of hands on buttocks and push slightly forward.
4. With a straight body, lean slightly backward until developmental stretch is felt in quadriceps; hold for 10 to 15 seconds.

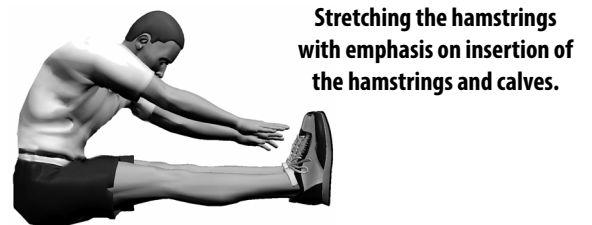

Stretching the hamstrings with emphasis on insertion of the hamstrings and calves.

POSTERIOR OF THIGH

Sitting Toe Touch

MUSCLE(S) AFFECTED: *hamstrings, spinal erectors and gastrocnemius*

1. Sit with the upper body nearly vertical and legs straight.
2. Lean forward from waist and grasp toes with each hand, slightly pull toes towards the upper body, and pull chest towards leg; hold for 10 seconds. (If you are very stiff, try to grasp the ankles.)
3. Release toes and relax foot.
4. Grasp ankles and continue to pull chest towards legs; hold for 10 seconds.
5. Still grasping the ankles, point away from body and continue to pull chest towards legs; hold for 10 seconds.



Stretching the hamstrings with emphasis on the middle portion.



Stretching the hamstrings with emphasis on the upper portion.

Warm Up/Cool Down Exercises

POSTERIOR OF THIGH

Semistraddle (Figure Four)

MUSCLE(S) AFFECTED: *gastrocnemius, hamstrings and spinal erectors*

1. Sit with the upper body nearly vertical and legs straight.
2. Place sole of left foot on left side of right knee. The lateral side of left leg should be resting on the floor.
3. Lean forward from the waist and grasp toes with right hand and slightly pull toes toward the upper body as the chest is also pulled toward right leg; hold for 10 seconds.
4. Release toes and relax foot.
5. Grasp ankle and continue to pull chest toward right leg; hold for 10 seconds.
6. Point toes away from body and continue to pull chest toward right leg; hold for 10 seconds.
7. Repeat with the left leg.



Stretching the hamstrings with emphasis on insertion of the hamstrings and calves



Stretching the hamstrings with emphasis on the middle portion



Stretching the hamstrings with emphasis on the upper portion



Stretching the hamstrings and groin with emphasis on insertion of the hamstrings and calves



Stretching the hamstrings and groin with emphasis on the middle portion



Stretching the hamstrings and groin with emphasis on the upper portion



Stretching the groin, low back and hamstrings

GROIN

Straddle (Spread Eagle)

MUSCLE(S) AFFECTED: *gastrocnemius, hamstrings, spinal erectors, adductors and sartorius*

1. Sit with the upper body nearly vertical and legs straight, and spread legs as far as possible.
2. With right hand, grasp toes of right foot and pull on toes slightly, while pulling chest toward right leg; hold for 10 seconds.
3. Release toes and relax foot.
4. Grasp ankle and continue to pull chest toward right leg; hold for 10 seconds.
5. Point toes away from body and continue to pull chest toward right leg; hold for 10 seconds.
6. Repeat process with the left leg.
7. Repeat process by grasping right toes with right hand and left toes with left hand. Move the torso forward and toward the ground.

UKRANCE®

by Body-Solid

Warm Up/Cool Down Exercises

GROIN

Butterfly

MUSCLE(S) AFFECTED: *adductors and sartorius*

1. Sitting with the upper body nearly vertical and legs straight, flex both knees as the soles of the feet come together.
2. Pull feet toward body.
3. Place hands on feet and elbows on legs.
4. Pull torso slightly forward as elbows push legs down; hold for 10 to 15 seconds.



Stretching the groin



Stretching calves without a step

POSTERIOR OF LOWER LEG

Bent-Over Toe Raise

MUSCLE(S) AFFECTED: *gastrocnemius and soleus*

1. Stand with heel of right foot 6 to 8 inches in front of left foot.
2. Flex right foot toward shin (dorsi-flexion) with heel in contact with floor.
3. Lean forward and try to touch right leg with chest while both legs are straight.
4. Continue to lean downward with upper body as the foot is dorsi-flexed near maximal toward the shin; hold for 10 to 15 seconds.
5. Repeat with the left leg.

POSTERIOR OF LOWER LEG

Step Stretch

MUSCLE(S) AFFECTED: *gastrocnemius and soleus;*
also, achilles tendon

1. Have ready a step or board 3 to 4 inches high.
2. Place balls of both feet on the step or board, 1 inch from its edge.
3. With straight legs, lower heels as far as possible; hold for 10 to 15 seconds.
4. To stretch achilles tendon, raise heels slightly. Slightly flex the knees and then lower the heels. This stretch will be felt in the achilles tendon; hold for 10 to 15 seconds.
5. For a more intense and individualized stretch, perform this stretch with one leg at a time.



Stretching the calves standing on a step



Preparing to stretch the achilles tendon by slightly bending the knee



Stretching the achilles tendon by lowering the heel

Warm Up/Cool Down Exercises

HIPS

Forward Lunge (Fencer)

MUSCLE(S) AFFECTED: *iliopsoas, rectus femoris*

1. Standing, take a long step forward (as with the lunge) with the right leg and flex the right knee until it is directly over the right foot.
2. Keep right foot flat on floor.
3. Keep back leg straight.
4. Keep back foot pointed in same direction as front foot; it is not necessary to have heel on floor.
5. Keep torso upright and rest hands on hips or front leg.
6. Slowly lower hips forward and downward; hold for 10 to 15 seconds.
7. Repeat with the left leg.



Stretching the hip flexors



Stretching the gluteals and hamstrings

HIPS

Supine Knee Flex

MUSCLE(S) AFFECTED: *hip extensors (gluteus maximus and hamstrings)*

1. Lie on back with legs straight.
2. Flex right leg and lift knee toward chest.
3. Place both hands below knee and continue to pull knee toward chest; hold for 10 to 15 seconds.
4. Repeat with left leg.

SHOULDER

Seated Lean-Back

MUSCLE(S) AFFECTED: *deltoids and pectoralis major*

1. Sitting with legs straight and arms extended, place palms on floor about 12 inches behind hips.
2. Point fingers away (backward) from body.
3. Slide hands backward and lean backward; hold for 10 seconds.



Stretching shoulder joints—sitting

URANCE®

by Body-Solid

Parts & Hardware List

Part#	Description	QTY
A	MAIN FRAME	1
B	UPRIGHT FRAME	1
C	HANDLE BAR	1
D	SEAT FRAME	1
E	ADJUSTMENT BRACKET	1
F	LEFT FOOT PEDAL	1
G	RIGHT FOOT PEDAL	1
H	CONSOLE	1
J	FRAME COVER	1
K	HANDLE COVER BOTTOM HALF	1
L	HANDLE COVER TOP HALF	1
M	BOTTLE HOLDER	1
N	LEFT REAR LEG COVER	1
P	RIGHT REAR LEG COVER	1
Q	FRONT COVER	1
1	LEFT CRANK	1
2	RIGHT CRANK	1
3	LEFT FRONT FOOT CAP	1
4	RIGHT FRONT FOOT CAP	1
5	M4x10mm PAN HEAD PHILLIPS SCREW	1
6	M10 NYLON LOCK NUT	4
7	M10 WASHER	4
8	ST3.5x1.6mm PAN HEAD PHILLIPS SCREW	6
9	ST4.2x18mm PAN HEAD PHILLIPS SCREW	36
10	M10x50mm SOCKET HEAD CAP SCREW	4
11	M5x10 PAN HEAD PHILLIPS SCREW	8
12	HEART RATE CABLE	2

Parts & Hardware List

Part#	Description	QTY
13	ST3.5x20mm PAN HEAD PHILLIPS SCREW	4
14	STEEL PLATE	1
15	WIRE HARNESS	1
16	HEART RATE CABLE	2
17	ADJUSTABLE PAD	2
18	WIRE HARNESS	1
19	POP PIN	1
20	REAR LEG END CAP	2
21	SEAT PAD	1
22	POSITION LIMITING BLOCK	1
23	M12x25mm HEX BOLT	2
24	M8 WASHER	3
25	M8 NYLON LOCK NUT	3
26	ø10.5x20x10mm BUSHING	1
27	KNOB	1
28	M12 LOCK WASHER	2
29	M12 WASHER	2
30	SEAT FRAME NYLON BUSHING	1
31	REAR HANDLE	1
32	M8x50mm BUTTON HEAD CAP SCREW	2
33	SENSOR ASSEMBLY	1
34	SPRING	1
35	STEEL PLATE	1
36	GENERATOR BRAKE CABLE	1
37	POWER CABLE	1
38	M4 WASHER	4
39	M4x6mm PAN HEAD PHILLIPS SCREW	4

URANCE®

by *Body-Solid*

Parts & Hardware List

Part#	Description	QTY
40	M6x18mm HEX HEAD BOLT	4
41	LEFT FRONT COVER	1
42	RIGHT FRONT COVER	1
43	LEFT BACK COVER	1
44	RIGHT BACK COVER	1
45	LOWER CONTROL BOARD	1
46	M6 WASHER	4
47	CRANK END CAP	2
48	M8x1x25mm FLANG BOLT	2
49	M6 NYLON LOCK NUT	8
50	M6 WASHER	9
51	AXLE	1
52	BELT	1
53	BELT WHEEL	1
54	M6x15mm LOW SOCKET HEAD CAP SCREW	4
55	Ø25.2x Ø30x8.7mm BUSHING	2
56	BEARING	2
57	TUBE END CAP	2
58	Ø25.2x Ø30x44mm BUSHING	1
59	Ø26x Ø32x0.3mm WASHER	1
60	M24x1.5 HEX NUT	1
61	GENERATOR BRAKE	1
62	STEEL ALLOY BUSHING	3
63	Ø5x Ø16x1.2mm WASHER	3
64	M5x17mm PAN HEAD PHILLIPS SCREW	3
65	M6x15mm PAN HEAD PHILLIPS SCREW	1
66	STEEL RING	1

Parts & Hardware List

Part#	Description	QTY
67	BEARING	2
68	CONNECTOR PLATE	1
69	WASHER	2
70	BATTERY HOLDER	1
71	BATTERY	1
72	CONSOLE FRONT COVER	1
73	CONSOLE BACK COVER	1
74	CONSOLE TOP COVER	1
75	TFT SCREEN	1
76	HEART RATE CABLE	2
77	CONSOLE HARNESS	1

URANCE®

by *Body-Solid*

Exploded Drawing

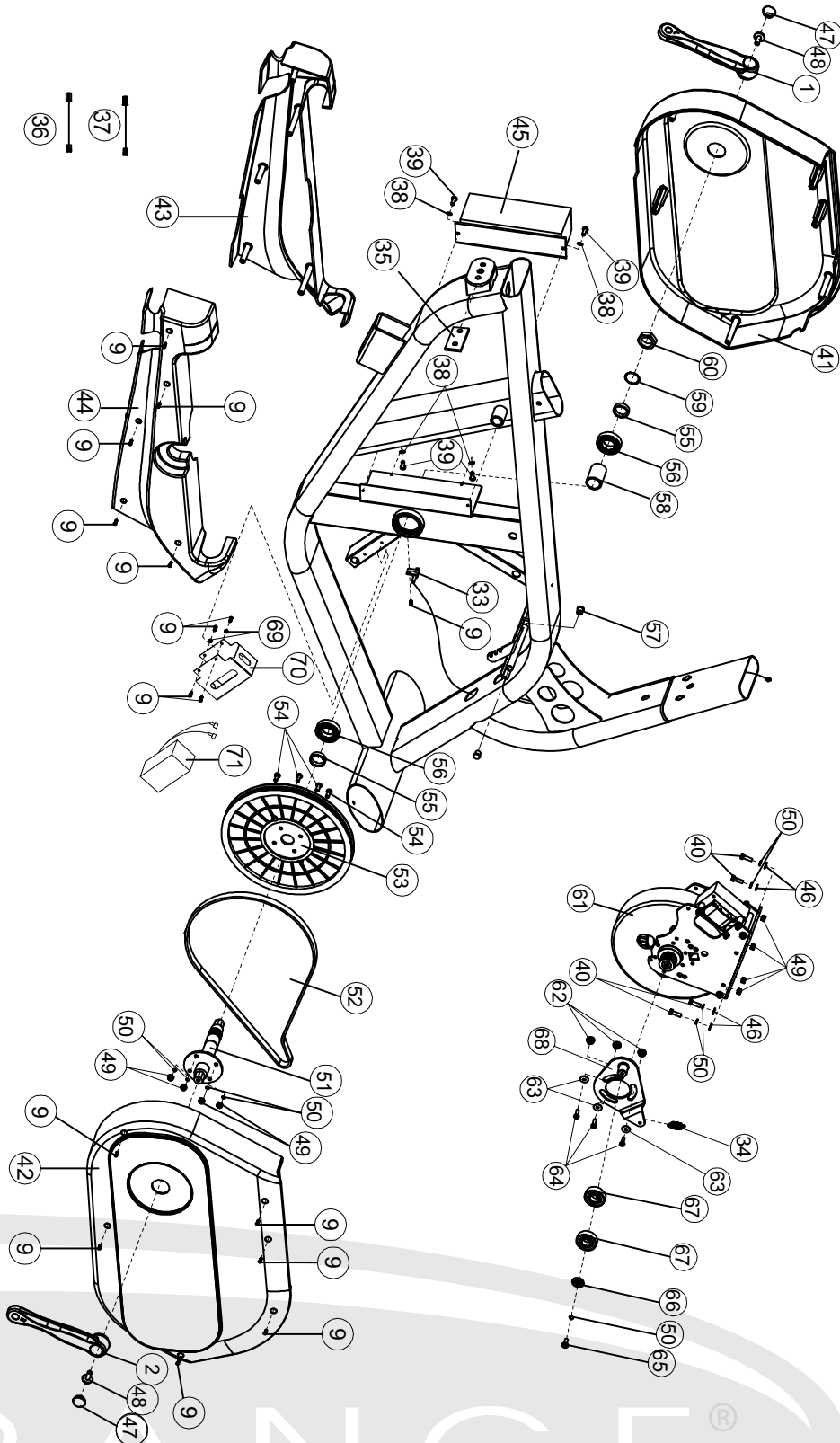

Exploded Drawing

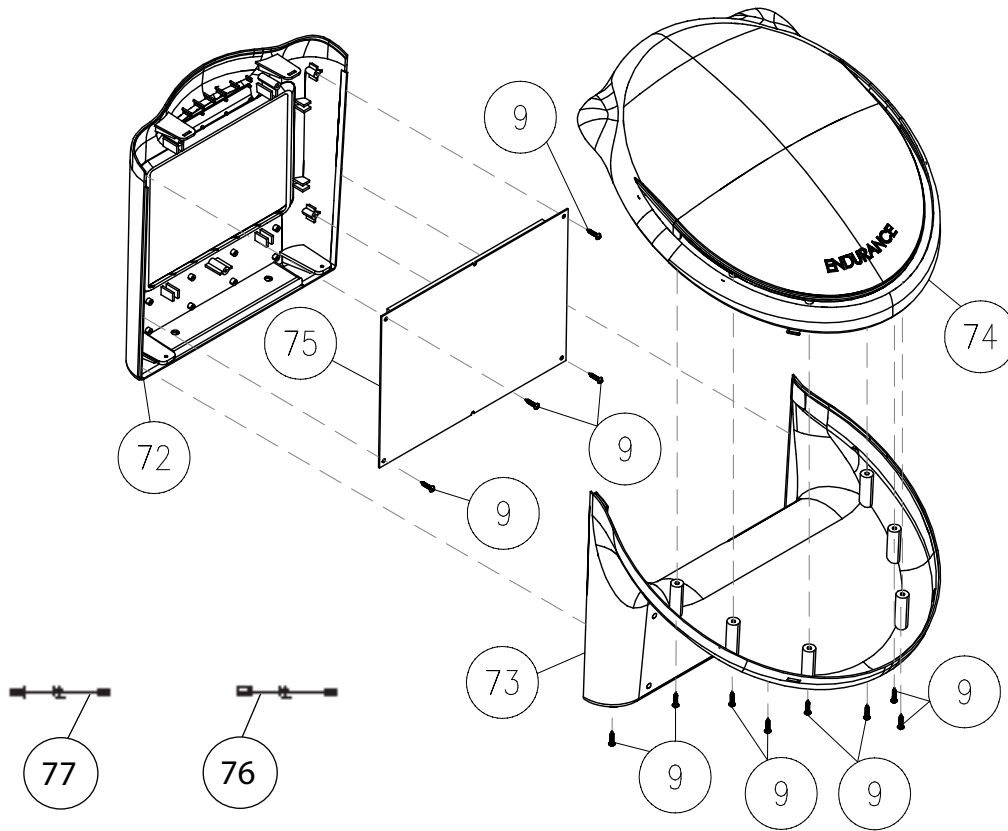



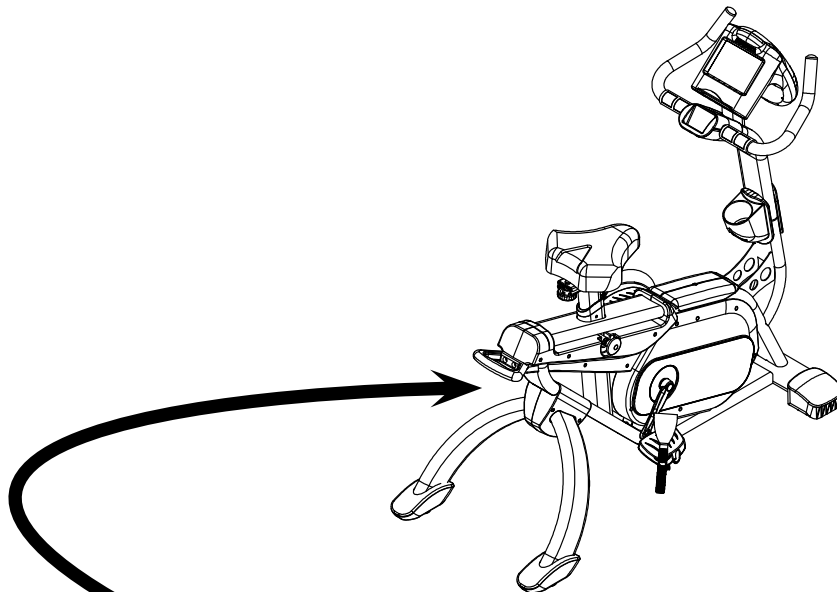

Serial Number is Located on the Frame

Model Name: _____ B5U _____

Purchase Date: _____

Serial Number: _____



Customer Tech Support Hotline

Toll Free: 1-800-556-3113
 Phone: 1-708-427-3555
 Fax: 1-708-427-3556
 Hours: M-F 8:30-5:00 CST
 E-Mail: service@bodysolid.com